

# JPEG2000 Stand alone DVR User Guide

## CONTENTS

Date: 2006/06/01 VER: 1.4

Caution	3
Package	3
Specification	4
<b>CHAP.1 Appearance</b>	
1-1 Front panel introduction	6
1-2 Back panel introduction	8
1-3 IR remote controller introduction	9
<b>CHAP.2 Installation</b>	
2-1 Camera and monitor installation	10
2-2 Sensor and alarm installation	11
2-3 Network and serial port installation	12
2-4 HDD installation	14
2-5 Power plugging	15
<b>CHAP.3 Operation</b>	
3-1 Display configuration	16
3-2 Screen switch/OSD position adjust	17
3-3 PIP view	17
3-4 Freeze view	17
3-5 View in sequence	18
3-6 Zoom view	19
3-7 Keylock	19
3-8 Record	20
3-9 Playback	21
<b>CHAP.4 Set up</b>	
4-1 Log-in	24
4-2 Display setup	25
4-3 Configuration	26
4-4 Record setup	34
4-5 Bak-up	37
4-6 External device	38
4-7 Factory default	42
4-8 Language	42

# JPEG2000 Stand alone DVR User Guide

---

## CHAP.5 CD-R bck-up

5-1 Data backup	43
5-2 CD-R player software installation	44
5-3 CD-R player software interface	45

## CHAP.6 PTZ camera control

6-1 PTZ camera installation	47
6-2 PTZ camera operation	48

## CHAP.7 Network & remote software

7-1 Network configuration	49
7-2 Network installation and setup	49
7-3 Router setup	52
7-4 Client software	54
7-5 DDNS setup and operation	62

## Appendix

1. Record time table	72
2. System configuration	74
3. Firmware upgrade	75
4. Play only mode	80

### Disclaimer:

- The product names mentioned in this manual are used as identifications only, while the copyright of these names might belong to other companies.
- The product spec and info are for reference only, and they may be updated from time to time without notification.

# JPEG2000 Stand alone DVR User Guide

## Caution

- For your safety, unplug the power before moving the DVR, installing, or replacing any parts or hard drive.
- Make sure all the power cable and wires are properly set up before using the DVR. Contact your distributor immediately if there is any defect.
- To avoid a short circuit, don't leave any unnecessary parts inside the DVR.
- Please avoid dramatic changes of the environment, such as dust, temperature, and humidity. Keep the DVR in a temperature ranging from 5°C~40°C.
- Keep the DVR in a well-ventilated place and away from any heat-generating objects.
- Do not block the DVR's fan and vent.
- Do not expose this unit to the sun directly.
- If you are not sure of the installation and setup, please consult the technicians.
- If there's any damage to this unit or the power supply, don't fix it yourself. Consult the technician or the distributor.

## Package

- DVR Main unit           × 1
- Power Supply           × 1
- Power Cable           × 1
- Remote Controller   × 1
- Manual                 × 1
- Software CD-R         × 1
- Accessories           × 1
- Battery                 × 4

Please contact your distributor immediately if any of the above items is missing.

# JPEG2000 Stand alone DVR User Guide

## Specification

Model	4/8/16 CH JPEG2000 Stand Alone DVR		
Video I/O	Video Input	4/8/16CH VIDEO IN 1.0 VP-P · 75OHM(BNC TYPE)	
	Video Output	(BNC TYPE) X 2	
	VGA Output	Support TFT LCD Monitor (Optional)	
Monitoring Method	Display Resolution	FULL: 720(H) × 480(V) (NTSC) 720(H) × 576(V) (PAL) 1/4: 360(H) × 240(V) (NTSC) 360(H) × 288(V) (PAL)	
	Split Screen	FULL/4/6/8/9/13/16 split	
	ZOOM IN/OUT	Live & Playback	
	PIP	Yes	
	Sequence	Yes	
Record Playback	Resolution	FULL	NTSC-720x240 / PAL-720x288
		DUAL	NTSC-360x240 / PAL-360x288
		QUAD	NTSC-360x120 / PAL-360x144
	Frame Rate	FULL	4CH: NTSC-60IPS/ PAL-50IPS 8/16CH: NTSC-120IPS/ PAL-100IPS
		DUAL	4CH: NTSC-120IPS/ PAL-100IPS 8/16CH: NTSC-240IPS/ PAL-200IPS
		QUAD	4CH: NTSC-240IPS/ PAL-200IPS 8/16CH: NTSC-480IPS/ PAL-400IPS
	Compression	JPEG2000	
	Quality	4CH: LOW	NTSC (12 KB/720x240)/PAL(14 KB/720x288)
		8/16CH: BASIC	NTSC (12 KB/720x240)/PAL(14 KB/720x288)
		4CH: MID	NTSC (18 KB/720x240)/PAL(20 KB/720x288)
8/16CH: NORMAL		NTSC (16 KB/720x240)/PAL(19 KB/720x288)	
4CH: HIGH		NTSC (24 KB/720x240)/PAL(24 KB/720x288)	
8/16CH: ENHANCED		NTSC (20 KB/720x240)/PAL(24 KB/720x288)	
4CH: SUPER		NTSC (32 KB/720x240)/PAL(32 KB/720x288)	
8/16CH: FINE	NTSC (24 KB/720x240)/PAL(29 KB/720x288)		
4CH: HYPER	NTSC (40 KB/720x240)/PAL(40 KB/720x288)		
8/16CH: SUPER FINE	NTSC (28 KB/720x240)/PAL(32 KB/720x288)		
Storage Device	HDD(EIDE, LBA mode, 3.5", 7200RPM)		
Monitoring Method	Record Mode	Real time/ motion /alarm /schedule	
	Search	Percentage/ Time & Date /Event	
	Shuttle Jog	For Easy Search	
	Fast Forward	x2, x4, x8, x16, x32, x60(NTSC)	
	Fast Rewind	x2, x4, x8, x15, x25, x50(PAL)	
	Slow Forward/Reward	1/2, 1/4, 1/8, 1/16	
	Picture by Picture	Available	

# JPEG2000 Stand alone DVR User Guide

<b>Network</b>	Protocol	TCP/IP
	Remote monitoring	Remote Software: Remote live view, playback, and save as AVI IE: Remote live view, backup, and save backup to AVI
<b>Assistant Functions</b>	Back-up	VCR, CD-R back-up, Backup via IE
	PTZ Control	RS485 · supports PELCO D and other protocols
	RS232	Controls DVR host through RS232
	Alarm Input	4CH: 4 Alarm Inputs 8CH: 8 Alarm Inputs 16CH: 16 Alarm Inputs
	Alarm Output	1(Programmable alarm output duration)
	Remote Controller	Infrared Remote Controller
	Control Device	Front Panel, Remote Controller, RS232
	Multi-language	English/Spanish/German/France/Chinese...
	HDD	1or2 HDDs, (160Gb or above )
<b>Mechanism</b>	Temperature	41 ° F~104 ° F (5 ° C~40 ° C)
	Humidity	Under 90%
	Dimension	430mm(W) x 400mm(D) x 92mm(H)
	Weight	8 KG (w/o HDD)
	Power	Switching Power (DC 12V, 8Amp)

# JPEG2000 Stand alone DVR User Guide

## CHAP.1 Appearance

### 1-1 Front panel introduction

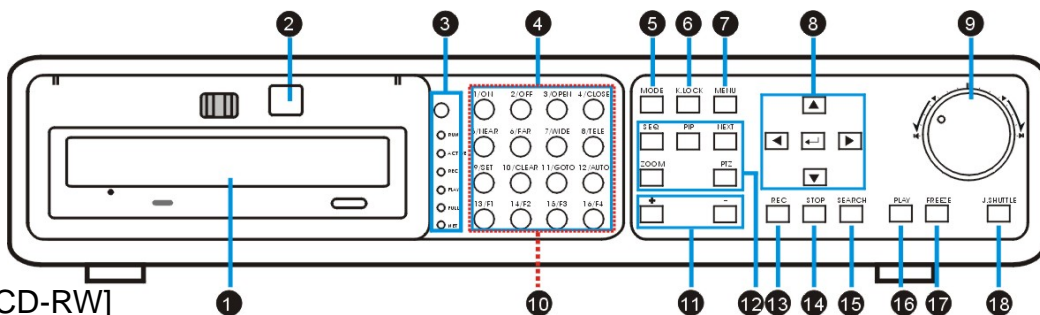

#### 1.[CD-RW]

- Built-in CD-RW for CD back-up.

#### 2.[USB Port]

- Connect PC for firmware upgrade.

#### 3.[IR Receiver & LED Lamps]

- IR Remote Controller Receiver.
- DVR Status LED:

RUN- Flashes when play picture by picture through J. Shuttle.

ACTIVE- On when the J. Shuttle is ready to use.

REC- On while recording and flashes at stand-by mode, such as no motion triggered at the motion record mode

PLAY- On while playback.

FULL- On when HDD storage is full.

NET- On when the DVR is connected remotely.

#### 4.[1~16 Channel Button]

- Switch full screen among channels, 1 for Channel 1, 2 for Channel 2, and so on.

#### 5.[MODE]

- Switch among full and split screen displays.

#### 6.[K.LOCK]

- Lock the buttons on front panel.

#### 7.[MENU]

- Enter the menu and set up.

#### 8.[Directions & ENTER]

- Directions- Navigate the menu.
- ENTER- Confirm the selected options.

#### 9.[Jog Shuttle]

- In playback: inner rim to play picture by picture, outer rim to play fast forward and backward. Turn clockwise to play fast forward, and counterclockwise to play fast backward.
- Turn the Jog Shuttle to change values in system set-up.

# JPEG2000 Stand alone DVR User Guide

---

## 10.[PTZ]

- Press [PTZ] to enter the PTZ control mode. Press the PTZ buttons to control the PTZ camera directly.

## 11.[+ / -]

- Adjust set-up value.
- Adjust display orders of channel.

## 12.[Control]

- SEQ- Full screen sequencing or the smaller screen sequencing in PIP mode.
- PIP- To enter the Picture in Picture mode from full screen mode.
- NEXT- Go to the next PTZ command in PTZ mode.

Go to the next channel in full screen display and the next page in split screen display.

- ZOOM- To enlarge the picture. Use the direction buttons and move to the area to be enlarged.

## 13.[REC]

- To activate Emergency Record at continuous, Super fine quality and Best resolution. Press STOP to exit the Emergency Record mode.

## 14.[STOP]

- Stop the emergency record and return to the record schedule programmed in the Record Setup.
- Stop playback and return to the LIVE mode.

## 15.[SEARCH]

- Enter the Search dialog window to search by percentage, date / time, or the event list.

## 16.[PLAY]

- Play the recorded data beginning from the end of previous playback.

## 17.[FREEZE]

- Freeze in full screen or split screen

## 18.[J.SHUTTLE Button]

- Activate the Jog Shuttle and press again to deactivate

# JPEG2000 Stand alone DVR User Guide

## 1-2 Back panel introduction

[4Channel]

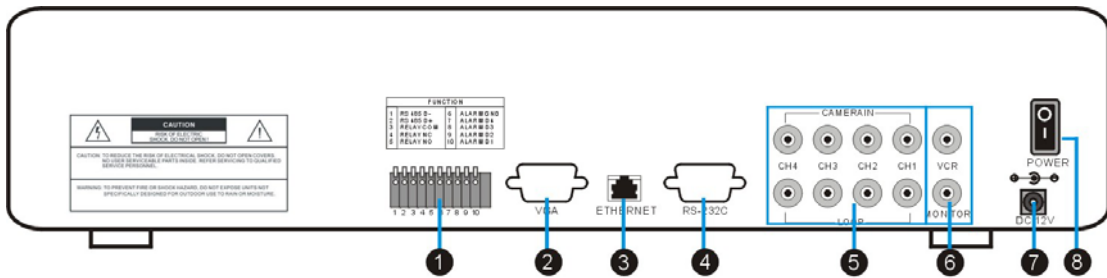

[8Channel]

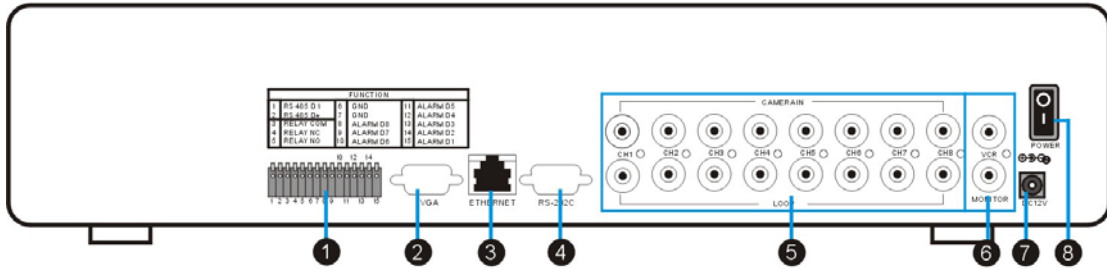

[16Channel]

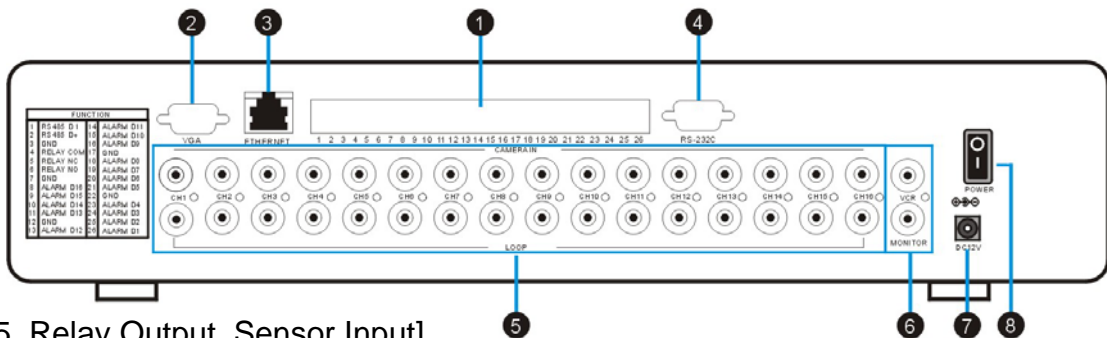

### 1.[RS485, Relay Output, Sensor Input]

- RS485, for connection to PTZ cameras.
- 16 sensor inputs and 1 relay output.

### 2.[VGA Output]

- Connection to a VGA monitor or TFT LCD.

### 3.[ETHERNET]

- Connection to Ethernet device.

### 4.[RS-232C]

- Connection to PC or other DVR control devices.

### 5.[1~16 Camera Input/LOOP Output]

- CAMERA IN- channel 1~16 camera input.
- LOOP- channel 1~16 camera loop out

### 6.[Monitor / VCR Output]

- MONITOR- Connection to monitor.
- VCR- Connection with VCR for analog backup.

### 7.[Power Input]

- DC power input (DC12V)

### 8.[Power Switch]

- Power ON/OFF



# JPEG2000 Stand alone DVR User Guide

## 1-3 IR remote controller introduction

### 1.[MENU]

- Enter menu or exit

### 2.[Split /OSD]

- 4S: 4 split
- 9S: 9 split
- 16S: 16 split
- OSD: OSD words on/off

### 3.[1~16 Channel]

- Switch channel in live or playback; password entering

### 4.[Control function]

- FRZ- Freeze the screen in display
- SEQ- Automatically display full screen or split screen in sequence
- ZOOM- To enlarge the picture. Use the direction buttons and move to the area to be enlarged.
- PIP- Picture in Picture. Enter PIP mode in full screen

### 5.[Mode/PT]

- MODE- Multi-screen display selection
- P/T- Enter the PTZ camera control mode

### 6.[SEARCH/-/+ /NEXT]

- SEARCH- Open the search window in playback
- [-]/[+]- For value adjustment in set-up
- NEXT- Go to the next PTZ command in PTZ mode.

Go to the next channel in full screen display and the next page in split screen display

### 7.[Rec]

- To activate Emergency Record at continuous, Super fine quality and Best resolution.

### 8.[Stop]

- Stop the emergency record and return to the record schedule programmed in the Record Setup.
- Stop playback and return to the LIVE mode.

### 9.[Functions]

- PLAY- Play the recorded data directly.
- PAUSE- Pause playback.
- REW- Fast rewind, press again to select the speed.
- FF- Fast forward, press again to select the speed.
- STEP- Play picture by picture.
- SLOW- Slow motion playback, press again to select the speed.

### 10.[ENTER]

- Select or adjust options in setup.

### 11.[Direction]

- Navigate the menu.

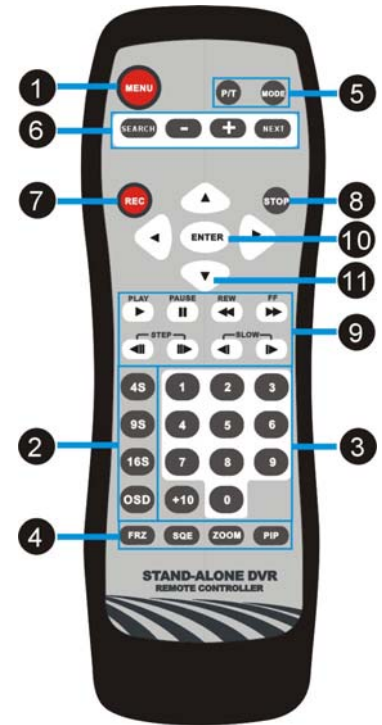

# JPEG2000 Stand alone DVR User Guide

## CHAP.2 Installation

### 2-1 Camera and monitor installation

#### 2-1-1 Camera installation

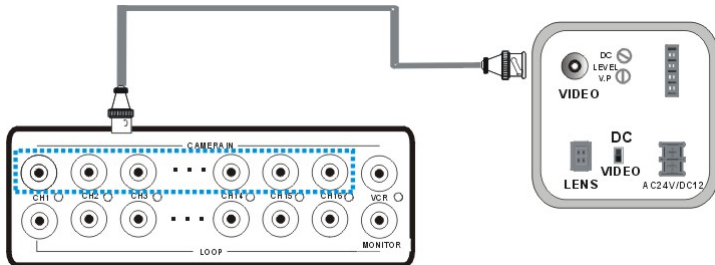

Connect camera to DVR camera in CH1~CH16

※Please do not start the DVR before the camera.

#### 2-1-2 Monitor and VCR installation

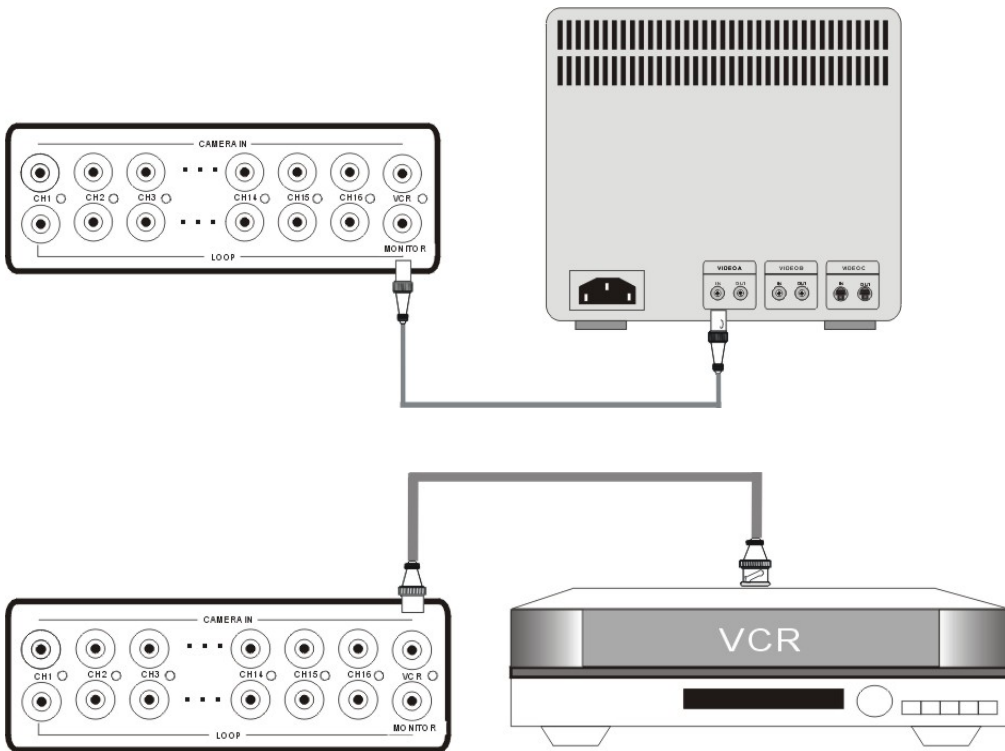

Monitor: Connect the MONTIOR port on the DVR back panel to the “video in” port on the monitor.

VCR: Connect the VCR port on the DVR back panel to the “Video In” on the VCR.

# JPEG2000 Stand alone DVR User Guide

## 2-1-3 Loop out installation

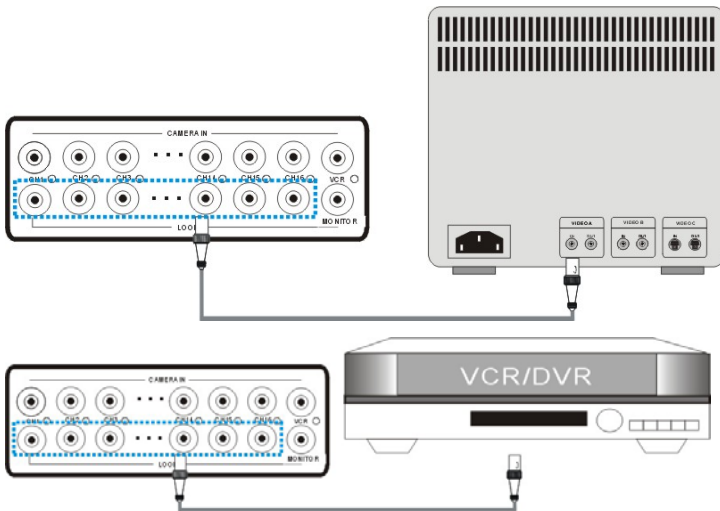

To monitor a single channel, connect the “loop out” of the corresponding channel to a monitor.

To record a specific channel individually, connect the “loop out” of the corresponding channel to a DVR, VCR, or other record device.

## 2-2 Sensor and alarm installation

### 2-2-1 Input & Output

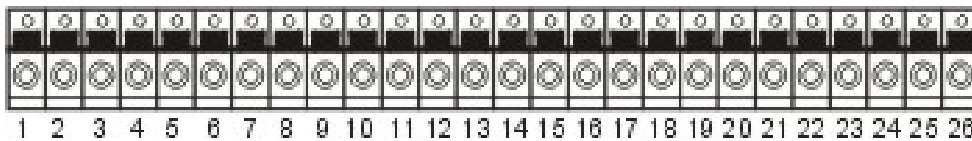

FUNCTION			
1	RS 48D D-	14	ALARM D11
2	RS 48D D+	15	ALARM D10
3	GND	16	ALARM D9
4	RELAY COM	17	GND
5	RELAY NC	18	ALARM D8
6	RELAY NO	19	ALARM D7
7	GND	20	ALARM D6
8	ALARM D16	21	ALARM D5
9	ALARM D15	22	GND
10	ALARM D14	23	ALARM D4
11	ALARM D13	24	ALARM D3
12	GND	25	ALARM D2
13	ALARM D12	26	ALARM D1

#### 1.[D1~D16 Alarm Input/GND for Location]

- 16 Sensor inputs, for sensor input installation

#### 2.[Relay Output NO/NC/COM]

- The application of relay output is NO+COM + NC+COM

### 2-2-2 Sensor installation

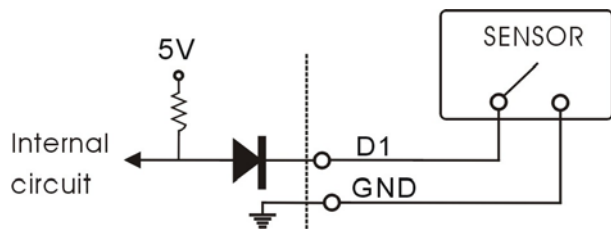

- Alarm will be triggered once one (or more than one) alarm input (D1~D16) causes short circuit or open circuit with GND.

# JPEG2000 Stand alone DVR User Guide

## 2-2-3 Relay output installation

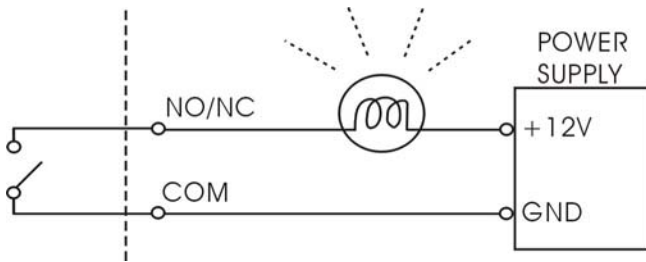

- Alarm output can be NO or NC, depending on the settings.
- NO-COM: the NO and COM terminals are open-circuit, and it'll become closed-circuit when alarm triggered.
- NC-COM: the NC and COM terminals are closed-circuit, and it'll become open-circuit when alarm triggered.

## 2-3 Network and serial port installation

### 2-3-1 Network setup

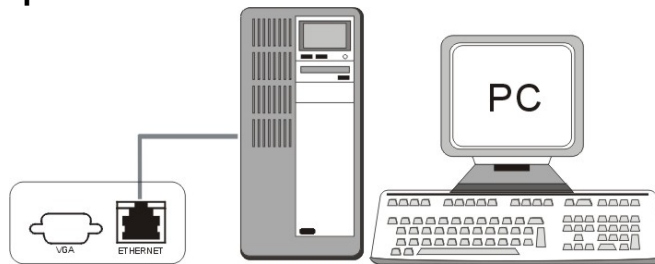

- Connect the network cable to "Ethernet" on back panel.
- Ethernet Setup between ADSL and Cable is different. For details, please refer to Ch. 7-2 Network installation.

### 2-3-2 Serial port setup

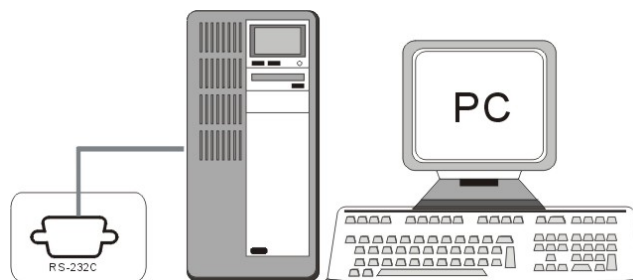

- User is able to connect the COM port of PC or other device to the DVR through RS232.
- RS232 settings (baudrate/ parity/ length/ stop bit ) are NOT adjustable.  
The transmission baudrate is 19200bps, length 8 bits, stop bit 1, and the parity is none.
- ASCII-CODE is 1 BYTE.

# JPEG2000 Stand alone DVR User Guide

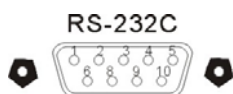

connector	description	ASCII-CODE									
1	DCD	Func.	CODE	Func.	CODE	Func.	CODE	Func.	CODE	Func.	CODE
2	RxD	REC	R	RIGHT	K	MODE	D	CH3	3	CH11	!
3	TxD	STOP	S	NEXT	N	PIP	I	CH4	4	CH12	@
4	DTR	PLAY	P	ENTER	0X0D	SEQ	Q	CH5	5	CH13	#
5	GND	SEARCH	E	-	<	J.SHU	L	CH6	6	CH14	\$
6	DSR	MENU	M	+	>	KLOCK	C	CH7	7	CH15	%
7	RTS	UP	U	PTZ	T	QPLAY	Y	CH8	8	CH16	^
8	CTS	DOWN	J	ZOOM	Z	CH1	1	CH9	9		
9	NC	LEFT	H	FRZ	F	CH2	2	CH10	0		

- To connect DVR to a PC, users must use a twisted RS232 cable, as the illustration.

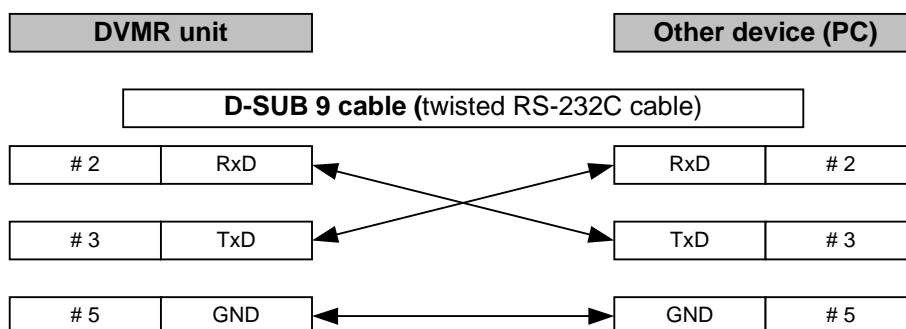

## 2-3-3 PTZ camera installation

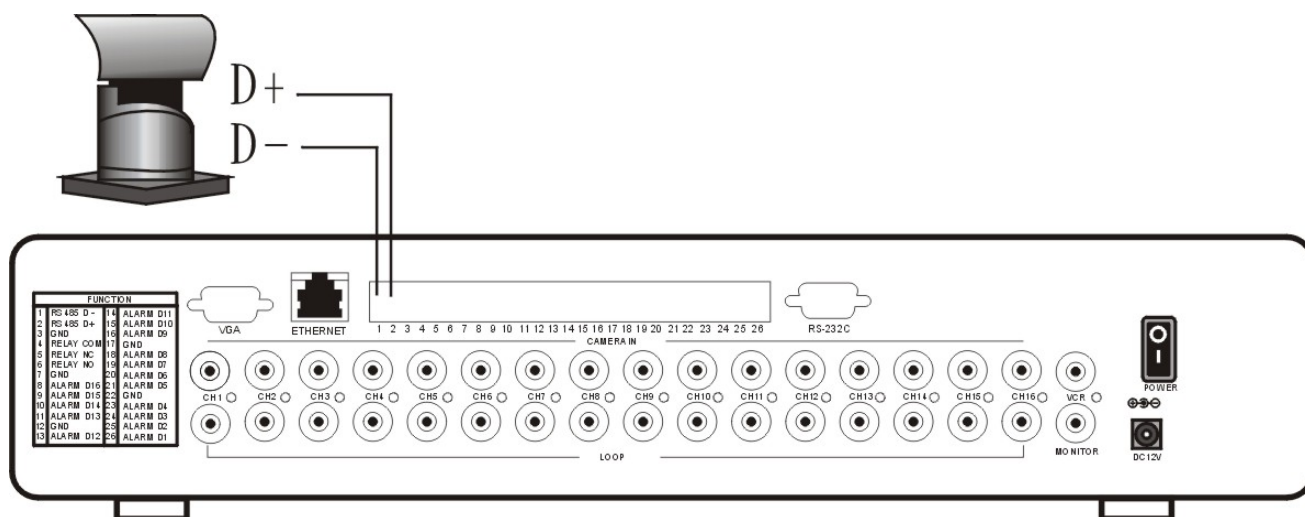

- Please connect the PTZ's D+ to the DVR's D+ , and D- to D-.
- After the connection and the related setup is done, users are able to control the PTZ camera through the front panel buttons. Please refer to Ch1 and Ch6.

# JPEG2000 Stand alone DVR User Guide

## 2-4 HDD installation

### [Steps]

1. Disassemble the bolts as illustrated.
2. Jumper setting

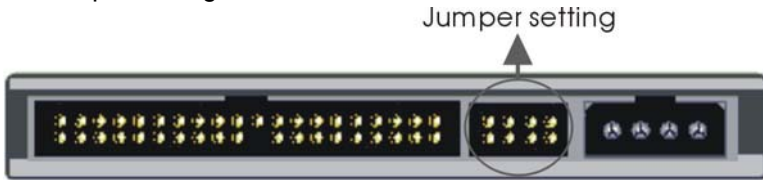

Set up the HDD as MASTER or SLAVE. Please refer to the HDD manual of the jumper settings.

### 3. HDD Installation

#### [One HDD installation]

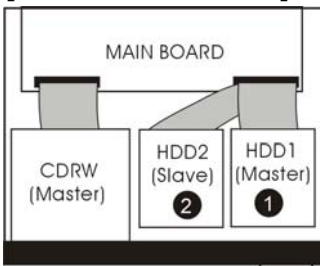

Please insert the HDD as shown in ❶, and make sure the HDD is set as "MASTER".

#### [Two HDDs installation]

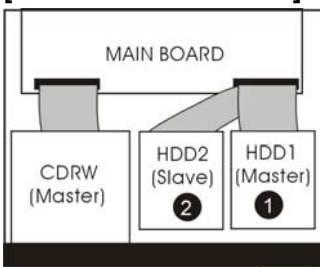

Please insert the first HDD as shown in ❶, (set up the jumper as "MASTER"); insert the second HDD as shown in ❷, (set up the jumper as "SLAVE")

#### Caution:

1. Power off the DVR before HDD installation.
2. Jumper setting must follow the instruction of HDD manufacturer.
3. Suggested HDD spec: Maxtor or Hitachi, 7200 RPM (or above), ATA-100

**Maxtor, Hitachi, and Seagate if firmware version is above V1.46.**

**\*DVR's Firmware version can be found in [SYSTEM MENU] ▶ [CONFIGURATION] ▶**

**[SYSTEM INFORMATION] ▶ [S/W VERSION]**

4. HDD storage 400GB (or above) is supported.
5. Don't set the HDD as "Cable Select", which may cause the DVR unable to record.

# JPEG2000 Stand alone DVR User Guide

## 2-5 Power plugging

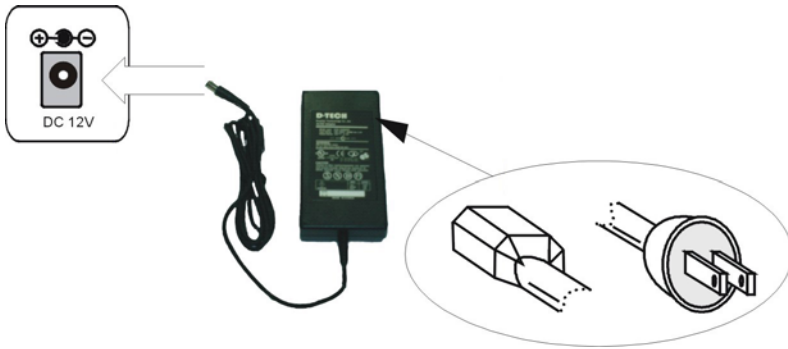

Insert the adapter to the rear power socket of DVR. Insert the power cable to the other side of adapter.

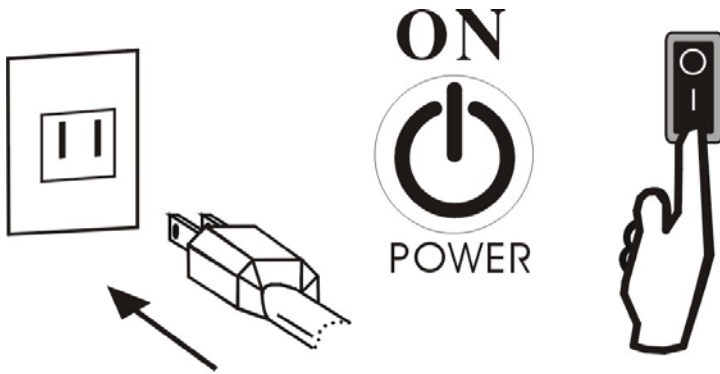

Plug in the power cable and power on the DVR.

**Caution: Please use a 100~240VAC 50~60HZ and 12VDC 8A or 5A power supply or it may damage the DVR.**

## CHAP.3 Operation

### 3-1 Display configuration

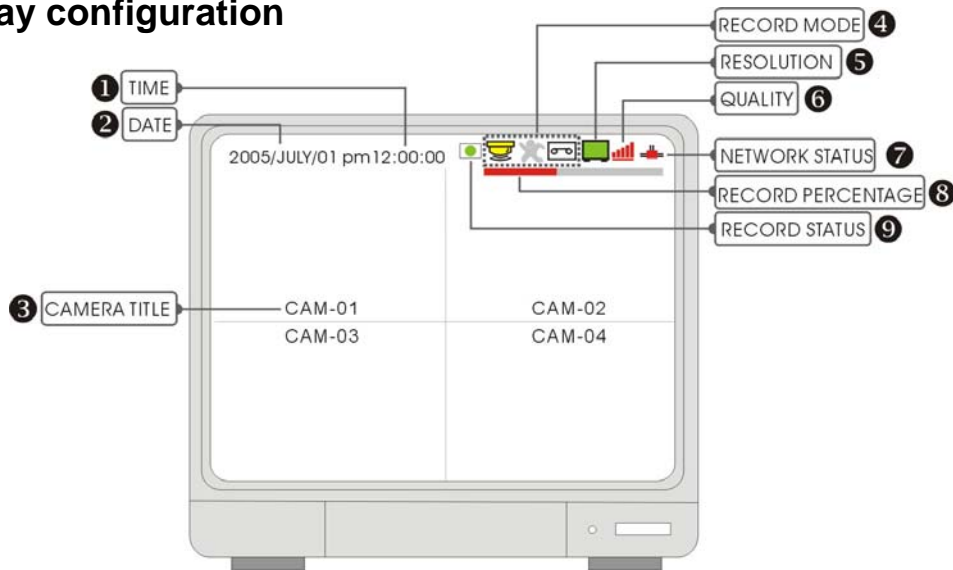

#### 1.[Time]

- Current system time or the recorded time in playback

#### 2.[Date]

- Current system date or the recorded date in playback







#### 3.[Camera title]

- Camera title of the displayed channel. Camera title can be modified in [SYSTEM MENU] ► [CONFIGURATION] ► [CAMERA SETUP] ► [CAMERA TITLE].

#### 4.[Record mode]

The current recording mode  alarm  motion  continuous



#### 5.[Record resolution]

- 4CH:  50IPS@720X288/60IPS@720X240  100IPS@360X288/120IPS@360X240  
 200IPS@360X144/480IPS@360X120
- 8/16CH:  50IPS@720X288/60IPS@720X240  100IPS@360X288/120IPS@360X240  
 200IPS@360X144/480IPS@360X120

#### 6.[Quality]

- To show record quality  Basic ~  Super Fine



#### 7.[Network LED]

- To show if there is a client connected.. Disconnected  Connected 

#### 8.[HDD record/search bar]

- In LIVE mode, the red bar means the HDD space used for record.
- In Playback mode, the red bar means the percentage of the data played.

#### 9.[Record status]

- To show the record status  Emergency record (Red)  scheduled record (Green)  
 Stop record (White)



# JPEG2000 Stand alone DVR User Guide

## 3-2 Screen switch/OSD position adjust

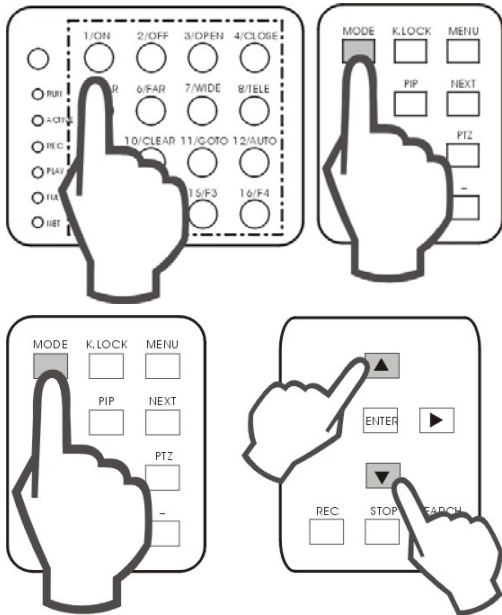

- ◆ Press the number button to switch to the corresponding channel for its full screen view
- ◆ Mode: press to switch among different split modes: 4/6/8/9/13/16 splits.  
+/-: button to adjust the order
- ◆ Adjust OSD position (High/Low):  
Low Position: Press "MODE"+"DOWN" at the same time  
High Position: Press "MODE"+"UP" at the same time  
Note: The OSD position returns to its default level after the DVR reboots.

## 3-3 PIP view

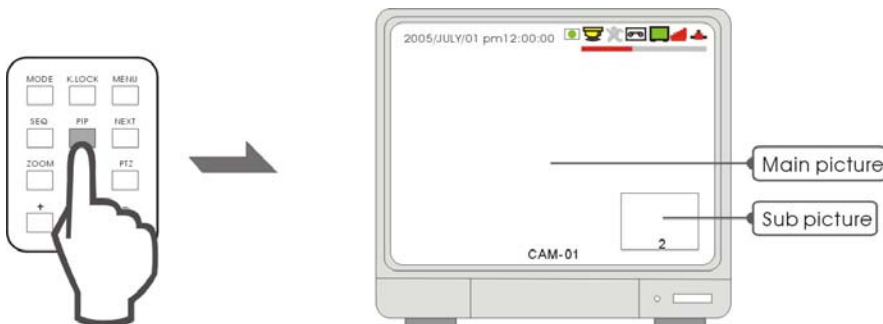

- In full screen mode, press "PIP" to enter PIP mode.
- Press "PIP" again to cancel.

## 3-4 Freeze view

### 3-4-1 Freeze in split mode

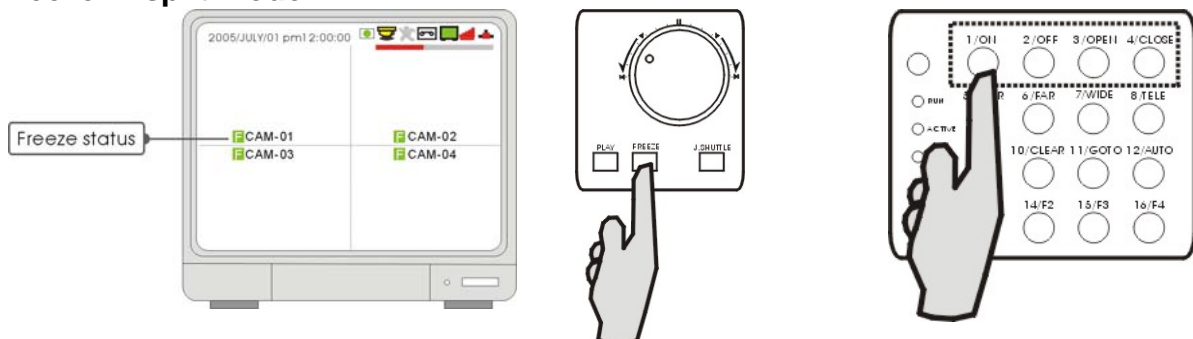

- In a split screen mode, press FREEZE and press a number button to select the corresponding channel to freeze. Press the number again to cancel.

# JPEG2000 Stand alone DVR User Guide

## 3-4-2 Freeze in Full mode

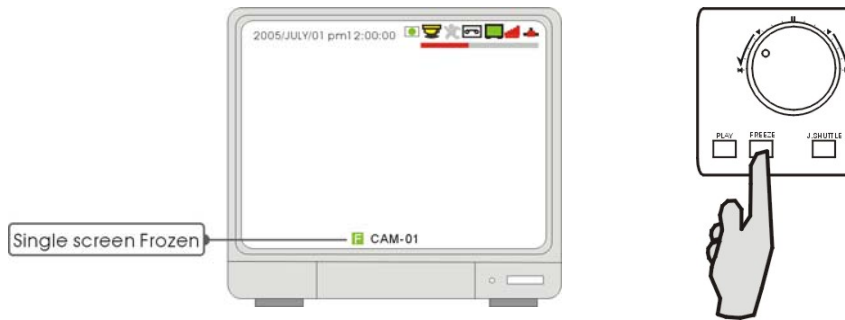

- In full screen mode, Press FREEZE to freeze the channel, and press FREEZE again to cancel.

## 3-5 View in sequence

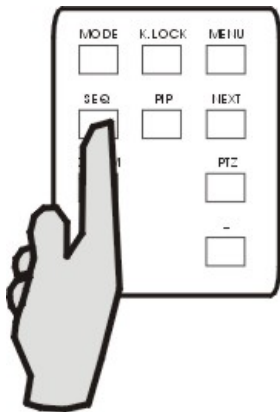

- Press SEQ to enter Sequential Switch and press SEQ again to cancel.



- Sequence order A > B > C > D ...>A > B ...
- Sequence time is adjustable in system setup. Please see [SYSTEM MENU] ▶ [CONFIGURATION] ▶ [INTERVAL SETUP] for details.

# JPEG2000 Stand alone DVR User Guide

## 3-6 Zoom view

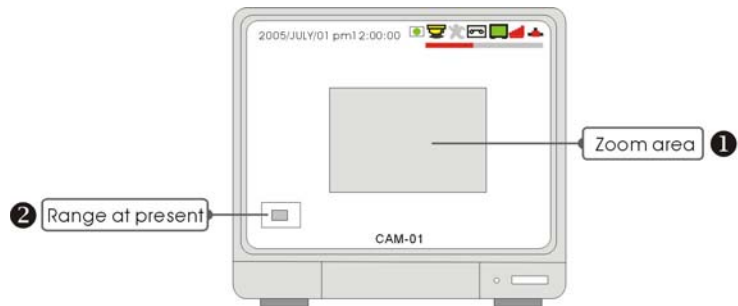
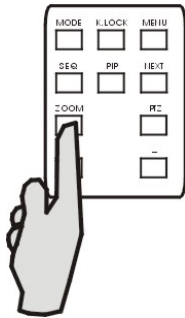

- Go to the channel to be zoomed and press ZOOM to enlarge to 200%, use direction buttons to move the enlarged part.
- Use the direction buttons to choose an area and press ENTER to zoom. Press ZOOM again to cancel

## 3-7 Key lock

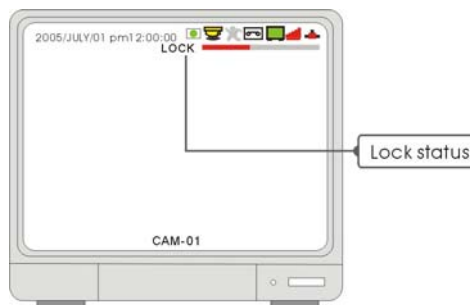
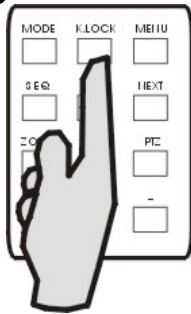

- After pressing "K. LOCK ", you'll see LOCK on screen and no button is functioning at this time. To unlock, press and hold K.LOCK and enter Admin's password.
- Please note that rebooting the DVR can not deactivate K.LOCK. You must enter ADMIN's password to unlock the keys.

# JPEG2000 Stand alone DVR User Guide

## 3-8 Record

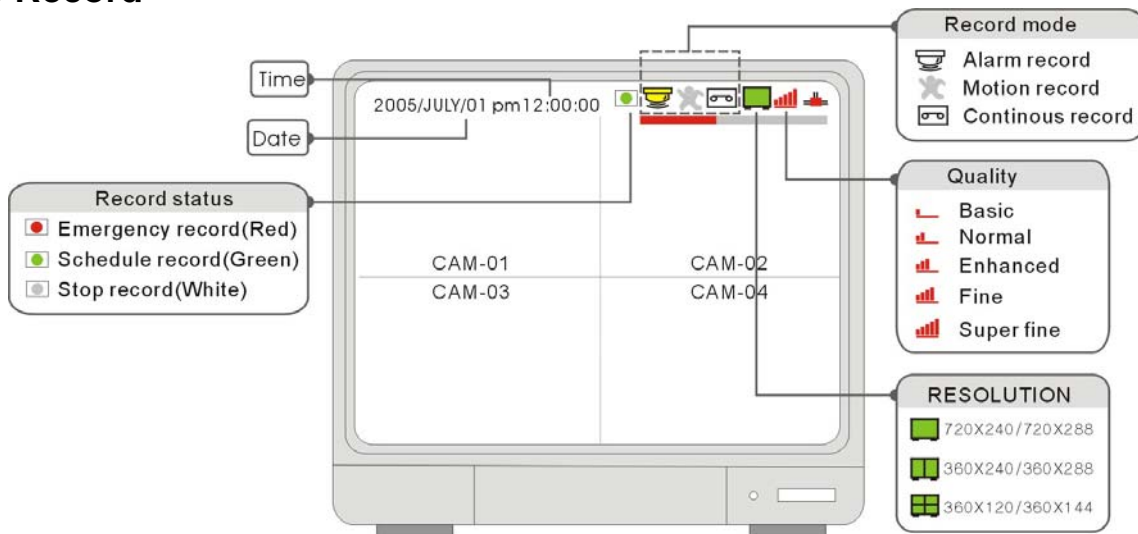

- Emergency record (Red): press REC to start emergency record at continuous record mode and at the best resolution and quality.
- Schedule record (Green): record at the setup schedule, record mode, resolution and quality
- Stop record (White): the white dot shows up when the record schedule is set to “not record” at this time.
- Record mode mark:
  - Alarm record: DVR records when the alarm is triggered
  - Motion record: DVR records when motion is detected
  - Continuous record: DVR records continuously
- If the power is cut off unexpectedly, the DVR will automatically resume its recording schedule after the power is back.
- Regarding record mode setup, please refer to the RECORD SETUP.

### [SEARCH BAR]



- The red bar means the percentage of the hard drive space used for recording data.

#### Under the following circumstances, the system stops recording:

1. when the DVR enters the menu
  2. No video inputs.
  3. When all cameras are set to record off.
  4. No motion is detected while the record mode is set to MOTION.
  5. When the record schedule is set to Not Record.
  6. Without clearing HDD or running factory defaults after a new HDD is installed.
  7. When the DVR enters the Search dialog window. The DVR, if set to Triplex Mode, resumes recording as soon as it enters playback.
- Besides the above circumstances, the DVR, if set to Duplex Mode, stops recording when the DVR enters Playback locally or remotely. Please see RECORD SETUP for DUPLEX and TRIPLEX setup details.

# JPEG2000 Stand alone DVR User Guide

## 3-9 Playback

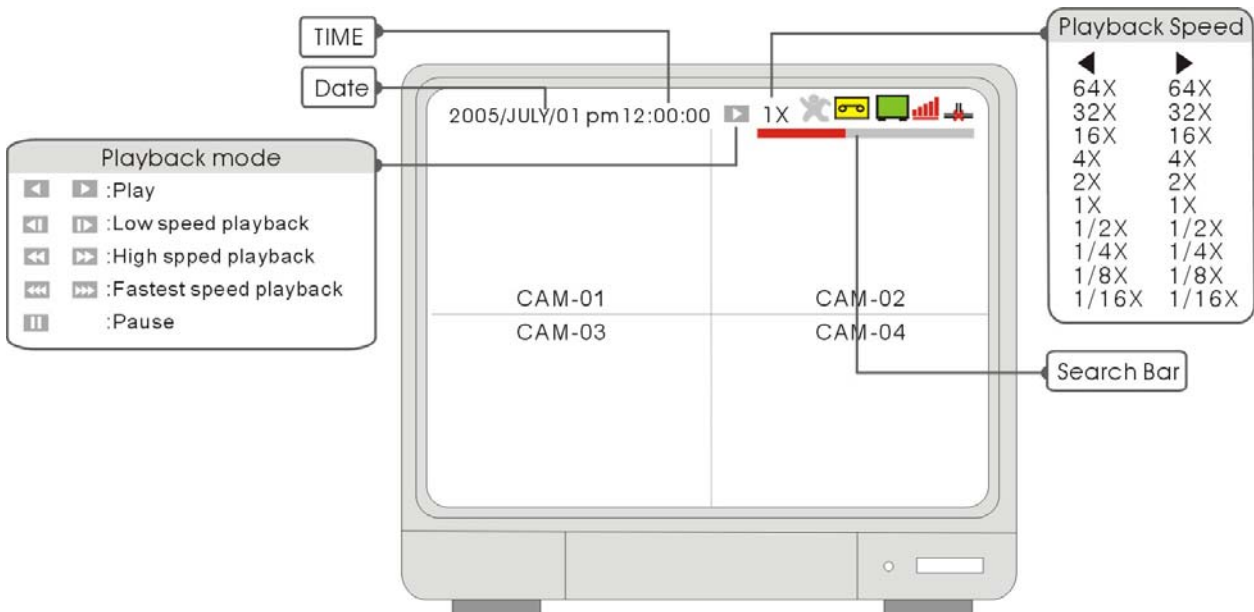

### 3-9-1 Play/Stop

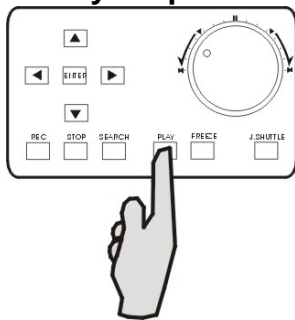

- Press PLAY key on front panel to start playback starting from the last playback time.
- Press“ PLAY ”during playback to choose to play forward or backward.
- Press“ STOP ”key to stop playback.

### 3-9-2 Search mode

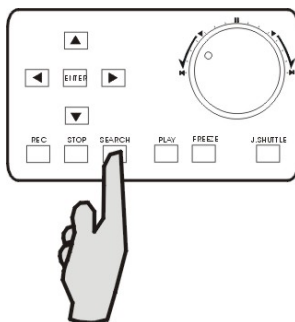

- Press SEARCH key to open the search dialog window. There are 3 modes for search: SEARCH BAR, TIME/DATE, EVENT LIST.

#### 1.[SEARCH BAR]

- Search by appointing a recording percentage. Using Jog-shuttle is a quick and convenient way to search.

#### 2.[TIME/DATE]

- Search by appointing a time and date

#### 3.[EVENT LIST]

- Search by Event list.

# JPEG2000 Stand alone DVR User Guide

## 3-9-3 SEARCH BAR

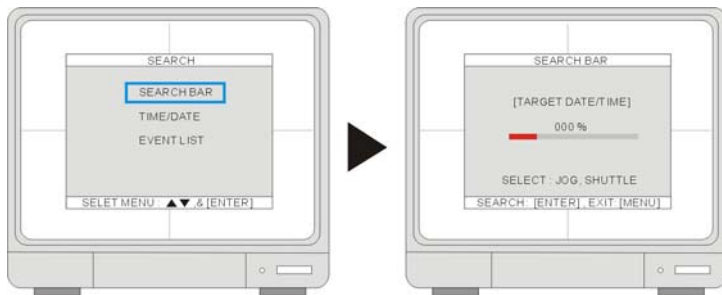

- Using Jog-shuttle or +/- keys to select the recording percentage of the search bar. Press “ ENTER ”key to confirm and start the playback.

## 3-9-4 TIME/DATE



1.[START] The start time and date of recording

- It shows that the start time and date of the recording data.

2.[END] The end time and date of recording

- It shows that the end time and date of the recording data.

3.[INPUT DATE/TIME] Input the appointed time and date to start playback.

- Select the time and date by +/- key to adjust numbers and by <=> key to adjust the cursor position.
- Then press “ Enter ”to start playback.

## 3-9-5 EVENT LIST

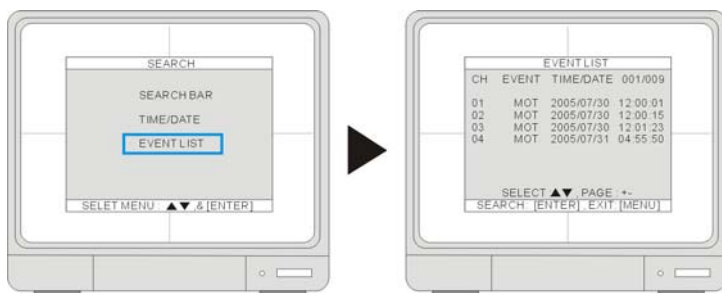

- CH- shows the channel in which the event happened
- EVENT- shows the type of events: Motion detection (MOT), Image lost (LOS), Alarm trigger(ALM).
- TIME/DATE- shows the event time and date.
- DVR keeps up to 1000 events in itsEVENT LIST.
- Using <=> key to select events and +/- key to change pages. ◦

# JPEG2000 Stand alone DVR User Guide

## 3-9-6 Playback speed adjustments

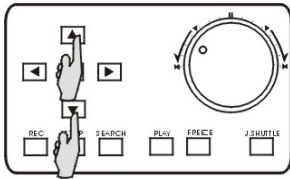

- While playback, using the direction keys to adjust the playback speed.
  - ▲ Speed up the playback ▼ Slow down the playback
  - ◀ Rewind ▶ Play in forward direction

The range of speed adjustment: 1/16X~1X, 1X~64X

- Press "J.SHUTTLE" key to pause the playback. Press "J.SHUTTLE" again to continue the playback.

## 3-9-7 Adjust Playback speed by JOG-SHUTTLE

- While playback, press "J.SHUTTLE" key to adjust the playback speed.

### 1.[High speed playback/Low speed playback/Forward Playback/Rewind Playback]

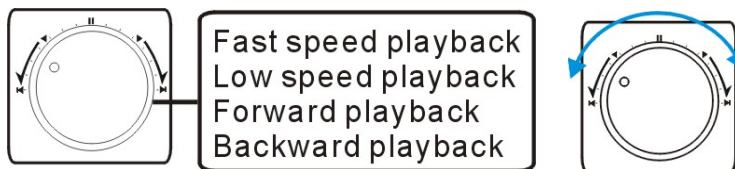

- Using the outer circle of Jog-shuttle to adjust the playback speed. Turn clockwise for forward direction, and turn counter-clockwise for Rewinding.

### 2.[Playback step by step]



- Using by inner circle of Jog-shuttle. Turn clockwise for forward direction and turn counter-clockwise for backward direction.

## 3-9-8 Adjust Playback speed by IR remote controller



While playback, select the direction keys of remote control to adjust the speed.

- ▲ X times high-speed playback. ▼ X times low speed playback.
- ◀ Rewind. ▶ Play in forward direction.



Adjust the speed by REW key (High-speed backward playback) or FF key (High-speed forward Playback). Press the keys repeatedly to adjust the speed rate.



Adjust the speed by SLOW-Motion keys (Slow playback in backward or in forward). Press the keys repeatedly to adjust the speed rate.

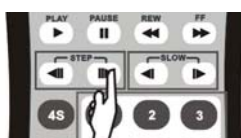

Playback picture by picture by STEP keys (Step playback in backward or in forward).

## CHAP.4 Set Up

### 4-1 Log-In

#### 4-1-1 DVR LOG-IN



- Press MENU to login DVR system.
- Use CH. SELECTORS 1~0 to key in the password.
- Then press ENTER to confirm and enter the system.
- Erase the wrong password by PIP key.

※ Default password:

ADMIN: blank (No default password. Press ENTER key directly to enter the system)

#### Caution:

1. It is strongly suggested to change the password after the initial setup. Please keep records of your passwords. Rebooting the DVR and resetting the factory defaults will not reset the password to the default.
2. Please contact your reseller if you forget the password.
3. The DVR will exit the Login screen and return to LIVE automatically if there is no action taken for 4 seconds.

#### 4-1-2 SYSTEM MENU

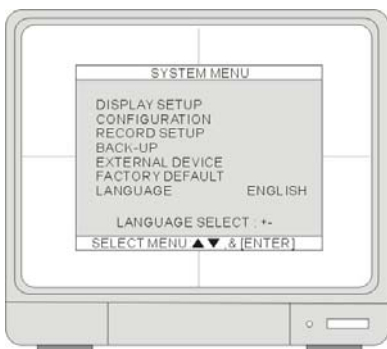

##### 1.[DISPLAY SETUP]

- Includes SCREEN DISPLAY, MONITOR SETUP (VGA SETUP)

##### 2.[CONFIGURATION]

- Includes HDD MANAGEMENT, TIME/DATE SETUP, CAMERA SETUP, INTERVAL SETUP, ALARM SETUP, BUZZER SETUP, PASSWORD SETUP, and SYSTEM INFORMATION.

##### 3.[RECORD SETUP]

- Includes RECORD CONFIGURATION, SCHEDULE SETUP, and HOLIDAY.

##### 4.[BACK-UP]

- Provide users to backup recorded data to CD Drive.

##### 5.[EXTERNAL DEVICE]

- Includes TCP/IP SETUP, RS232C SETUP, PAN-TILT SETUP.

##### 6.[FACTORY DEFAULT]

- Reset the DVR to factory defaults.

##### 7.[LANGUAGE]

- Change the OSD language.

※Use ▲ or ▼ key to select the items and press ENTER to go into selection.

※Press MENU to go to the previous setup page or to exit SYSTEM SETUP.



## 4-2 Display setup

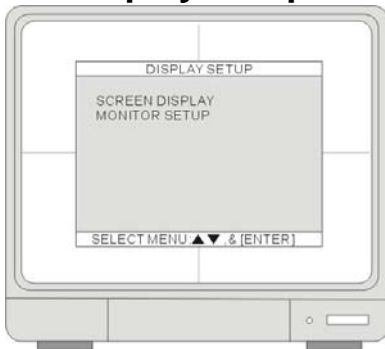

### 1.[SCREEN DISPLAY]

- Set up which information to be displayed at the Live and Playback mode.

### 2.[MONITOR SETUP]

- Adjust the VGA display resolution and the monitor color.

### 4-2-1 Screen display

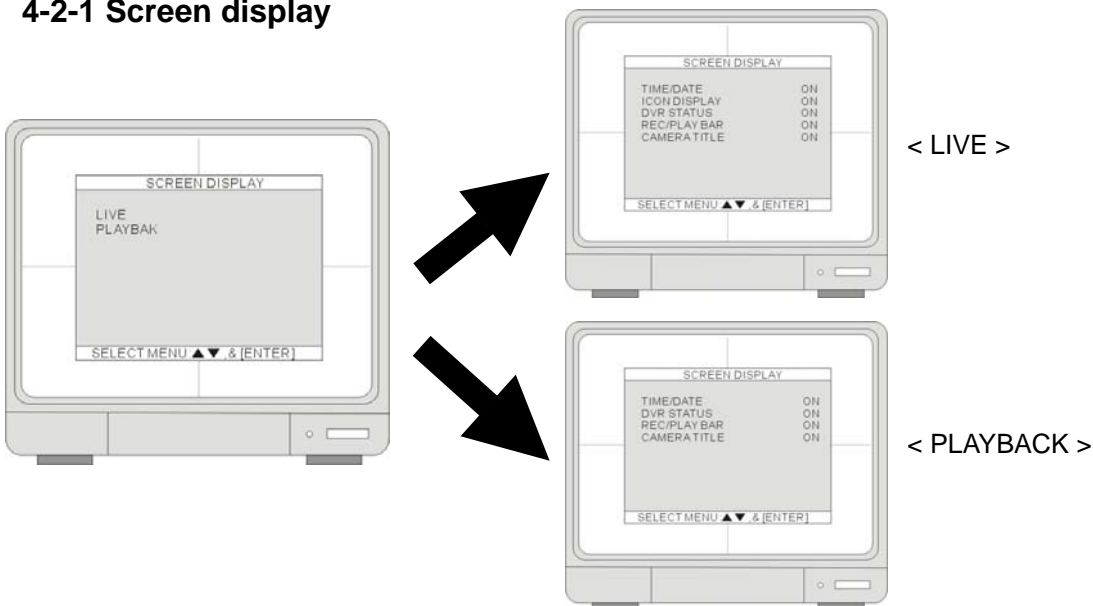

Use ▲▼ to select an item and press ENTER to switch between ON and OFF.

#### 1.[LIVE]

- Set up the following information to be displayed or not at the Live mode.
- TIME/DATE – Display (ON) or hide (OFF) the time and date.  
ICON DISPLAY - Display (ON) or hide (OFF) the cue icons on the screen.  
DVR STATUS - Display (ON) or hide (OFF) the recording status on the screen.  
REC/PLAY BAR - Display (ON) or hide (OFF) the recording percentage of HDD.  
CAMERA TITLE - Display (ON) or hide (OFF) the camera title.

#### 2.[PLAYBACK]

- Set up the following information to be displayed or not at the Playback mode.
- TIME/DATE- Display (ON) or hide (OFF) the time and date.  
DVR STATUS- Display (ON) or hide (OFF) the cue icons on the screen.  
REC/PLAY BAR- Display (ON) or hide (OFF) the recording percentage of HDD.  
CAMERA TITLE- Display (ON) or hide (OFF) the camera title.

# JPEG2000 Stand alone DVR User Guide

## 4-2-2 Monitor setup

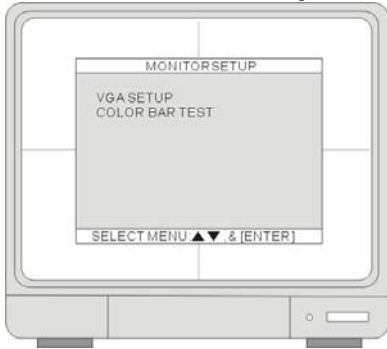

### 1.[VGA SETUP]

- Set up the VGA resolution.

### 2.[COLOR BAR TEST]

- Adjust the monitor colors by the color bar.

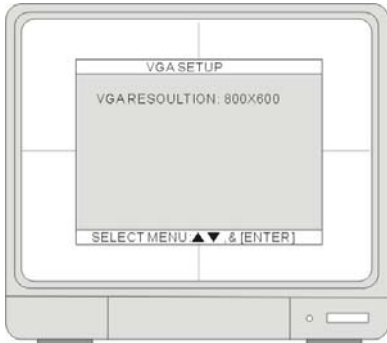

- VGA resolution setup:

1024\*768/60HZ 、 800\*600/60HZ 、 640\*480/60HZ 、

1024\*768/75HZ 、 800\*600/75HZ 、 640\*480/75HZ

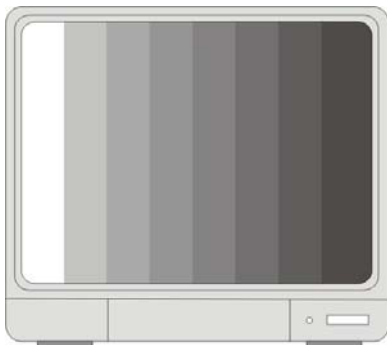

- Monitor colors' adjustment by Color Bar.

## 4-3 Configuration

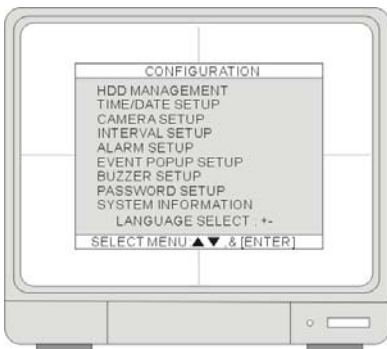

### 1.[HDD MANAGEMENT]

- Includes HDD SETUP (HDD Clear), and HDD INFORMATION.

### 2.[TIME/DATE SETUP]

- Program the system date and time.

### 3.[CAMERA SETUP]

- Includes CAMERA TITLE, CAMERA COLOR SETUP, CAMERA ACTIVE SETUP, and MOTION SETUP.

### 4.[INTERVAL SETUP]

- Set up the switch interval of the Full screen and the PIP screen.

### 5.[ALARM SETUP]

- Set up the Alarm mode (N.C. or N.O) and the Alarm Output Duration.

### 6.[EVENT POPUP SETUP ]

- Set up the POP-UP function ON or OFF: When set to ON, the screen display switches to a full screen of the channel which has alarm triggered or motion detected.

# JPEG2000 Stand alone DVR User Guide

## 7.[BUZZER SETUP]

- Set the Buzzer ON or OFF at a certain condition.

## 8.[PASSWORD SETUP]

- Setup the password.

## 9.[SYSTEM INFORMATION]

- Show the system information, such as the versions of S/W and H/W, HDD model number, and CD-R model number.

### 4-3-1 HDD management

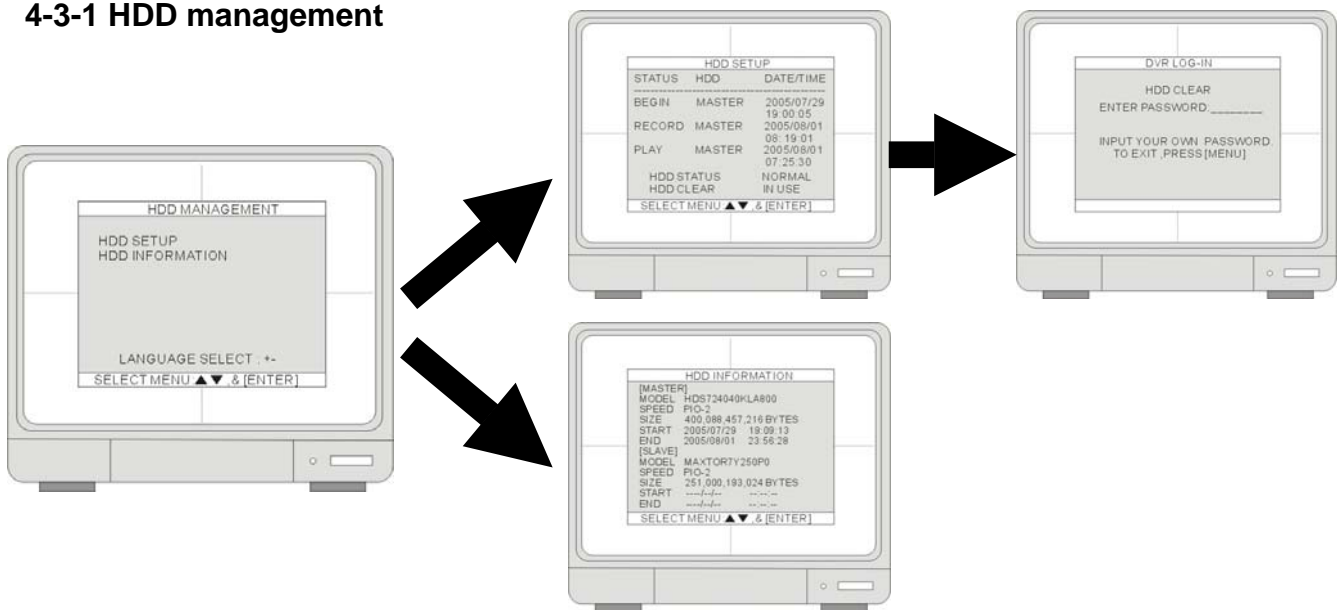

#### 1.[HDD SETUP]

- BEGIN- Indicate the start Date/Time of recorded data on HDD (Master/Slave).  
RECORD- Indicate the end Date/Time of recorded data on HDD (Master/Slave).  
PLAY- Indicate the previous playback Date/Time on HDD (Master/Slave).
- STATUS- Indicate the HDD status as empty/normal/overwrite  
CLEAR HDD- To clear the HDD data, enter the ADMIN's password to execute this function.

#### 2. [HDD INFORMATION]

- This menu shows the physical information of HDD (Master/Slave).

# JPEG2000 Stand alone DVR User Guide

## 4-3-2 Time/date setup

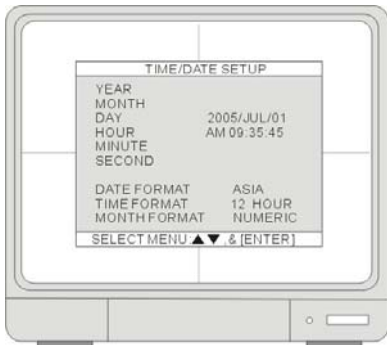

- The date and time set by the manufacturer maybe different from your time zone. It is very important to set up they system date and time before the DVR starts recording. Set the date and time by using direction buttons and [-][+] button or Jog shuttle.
- Date format- Asia/American/European  
Time format- 12 hours/24 hours  
Month format- English/Numeric

1.We strongly suggest completing the following settings at the initial setup.

- (1) Set up the time/date, and RUN all factory defaults.
- (2) Go to HDD management and CLEAR HDD
- (3) "RUN" all factory defaults.

2.DO NOT change the date and time after the recording starts It may corrupt the DVR's data archive and cause playback errors. If it is necessary to change date and time after the recording starts, please run the above steps to avoid malfunctioning.

## 4-3-3 Camera setup



- 1.[CAMERA TITLE]
  - Set up the camera title channel by channel.
- 2.[CAMERA COLOR SETUP]
  - Set up the camera color channel by channel.
- 3.[CAMERA ACTIVE SETUP]
  - Turn the camera ON or OFF at LIVE and Record.
- 4.[MOTION SETUP]
  - Program the motion parameters and the detection area

### [CAMERA TITLE]

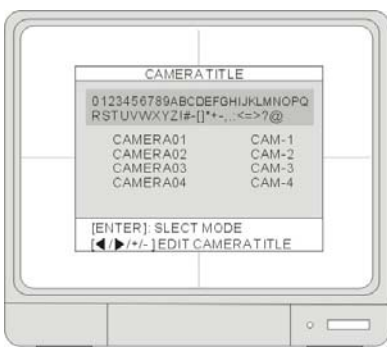

- Input the camera Title, max. 8 characters.  
Using [Left] or [Right] and [-][+] buttons to change the value. When the modification is finished, press [Enter]. To return to the previous menu, press the [MENU] button.

# JPEG2000 Stand alone DVR User Guide

## [CAMERA COLOR SETUP]



- Adjust the image color: Use [UP] and [DOWN] to select an item and use [-] and [+] or Jog shuttle to adjust the values.
- CHANNEL: Select the camera to be modified.  
BRIGHTNESS: Adjust image brightness (-32~31).  
CONTRAST: Adjust color contrast (-32~31).  
SATURATION: Adjust color saturation (-32~31).  
HUE: Adjust color hue (-32~31).

## [CAMERA ACTIVE SETUP]



- Use the direction buttons to select an item and press [ENTER] to select ON and OFF. If a channel is set to OFF at LIVE and ON at RECORD, the channel will be recorded, displayed during Playback, but will not be displayed at LIVE.

### 1.[STATUS]

- Indicate the camera status: ACTIVE means the video input status is normal, and LOSS means the video is lost.

### 2.[LIVE]

- Set up the channel to be displayed or not at the LIVE screen.

### 3.[REC]

- Set up the channel to be recorded or not.

## [MOTION SETUP]

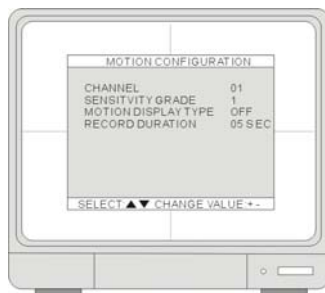
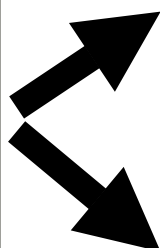
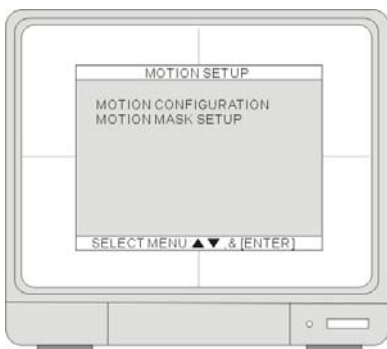

< MOTION CONFIGURATION >

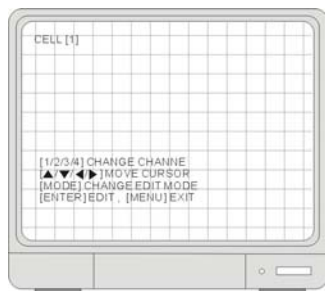

< MOTION MASK SETUP >

# JPEG2000 Stand alone DVR User Guide

## [MOTION SETUP]

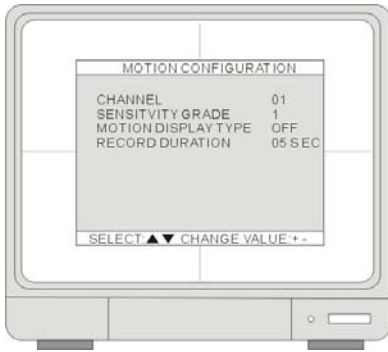

### 1.[CHANNEL]

- Select a channel for the setup.

### 2.[SENSITIVITY GRADE]

- Adjust motion detection sensitivity. 1 (LOW)~4 (VERY HIGH)

### 3.[MOTION DISPLAY TYPE]

- Setup the display type that marks the motion area.
- **BOX-** shows block / **CELL-** shows green lattice

### 4.[RECORD DURATION]

- The DVR record for duration from the time motion is detected. If the DVR detects motion continuously, the DVR keeps recording through out the event, and the duration after the last motion event. For example, the duration is set to 10 seconds and the motion last for 3 minutes. The DVR records for 3 minutes and 10 seconds.

## [MOTION MASK SETUP]

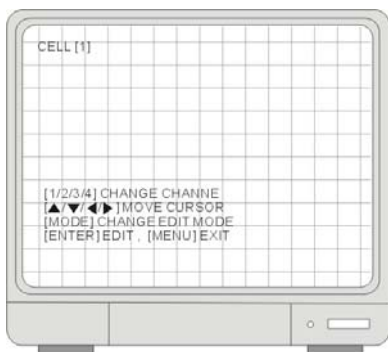

Users can set up which area to detect motion and which not to detect. The area that is marked not to detect motion is Grey.

- Press the number button to select the channel.
- Set motion detection area. Use the Direction buttons to move the cursor and press [ENTER] to mark the area.
- Press [Mode] to change the editing mode. The editing modes are as below:

**1.Cell:** Move to the desired location and press [ENTER] to activate or deactivate the motion detection in the marked area cell by cell.

**2.ALL ON:** Change the mode to ALL ON and press ENTER to activate the motion detection in the whole window.

**3. ALL OFF:** Change the mode to ALL OFF and press ENTER to deactivate the motion detection in the whole window.

**4.BLOCK ON:** Block an area to activate the motion detection in the desired area. Move the cursor to a corner cell of the desired area and press ENTER to mark the starting cell of the block. Then, move the cursor to the cell at the diagonal end of the desired area and press ENTER to finish marking the block. When the window is at the ALL OFF mode, you can activate the motion detection in the block.

**5.BLOCK OFF:** Block an area to deactivate the motion detection in the desired area. The setup steps are the same as BLOCK ON. If the window is at the ALL ON mode, you can deactivate the motion detection in the block you make.

- CELL [1]

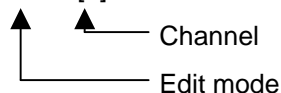

### Note:

Please go to [RECORD SETUP] > [SCHEDULE RECORD] and change the record mode to MOTION to activate the MOTION settings,

# JPEG2000 Stand alone DVR User Guide

## 4-3-4 Interval setup



### 1.[SWITCH INTERVAL]

- FULL- Full Screen Sequence Interval setup. (Range: 1~99 SEC)
- PIP- Picture in Picture, the sub-picture's sequence interval setup. (Range: 1~99 SEC)

### 2.[EVENT RECORD]

- Event Update Time is to avoid the DVR from recording the event logs from the same event. The event types include alarm, motion and video loss. When an event is triggered, it is possible that the same event keeps on being triggered for a period of time. With the help of Event Update Time, whenever there is an event, the DVR records the starting time and information of the event in the Event Log, and ignores the following events within the duration set in the Event update time. The setting range of the Event Update time is from 10 seconds to 990 seconds.

## 4-3-5 Alarm setup

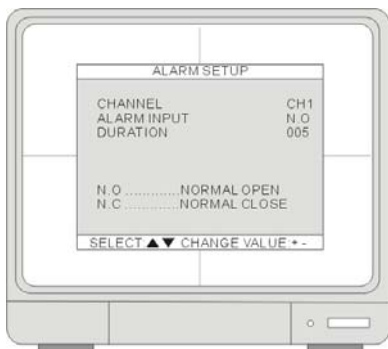

### 1.[CHANNEL]

- Use [+] and [-] to select a channel.

### 2.[ALARM INPUT]

- Set up the Alarm Input type.
- N.C- when the alarm is triggered, the circuit turns closed (ON).
- N.O- when the alarm is triggered, the circuit turns opened (OFF).

### 3.[DURATION]

- Set up a post- alarm recording duration and the alarm output duration. The duration setting is applied to both functions. The setting range is from 1 second to 300 seconds.

Note: Alarm output can be triggered by alarm input and video loss. Motion cannot trigger an alarm output.

## 4-3-6 Event popup setup

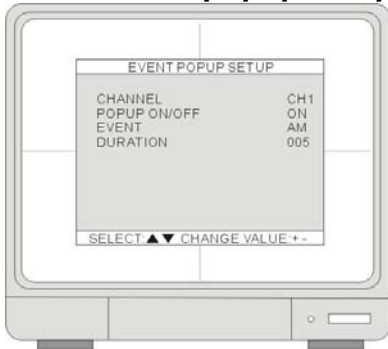

### 1.[CHANNEL]

- Use [+] and [-] to select a channel.

### 2.[POPUP ON/OFF]

Set up the POPUP function ON/OFF: Use [+] and [-] to select ON or OFF. When there is an event, the screen display will switch to a full screen of the corresponding channel.

### 3.[EVENT]

- Use [+] and [-] to select the event type that will trigger the POPUP:  
**A-** Alarm / **M-** Motion / **AM-** Alarm or Motion.

### 4.[DURATION]

- Use [+] and [-] to set up a duration of the POPUP. The setting range is from 1 second to 60 seconds. When the Event POPUP finishes, 4CH DVR returns to its Quad screen display, 8CH DVR 9 -Split screen display, and 16CH DVR 16-Split screen display.

## 4-3-7 Buzzer setup

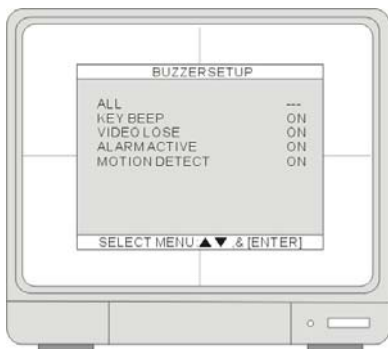

Set up the condition that triggers the buzzer to beep. Use [UP] and [DOWN] to select an item and press ENTER to turn ON or OFF the selection.

### 1.[ALL]

- Turn ON or OFF of all the conditions that trigger the buzzer to beep. You can also setup the buzzer by the conditions. Move the cursor to the desired selection and press ENTER to turn ON or OFF the selection.

### 2.[KEY BEEP]

- Turn on/off the beep while operating the front panel.

### 3.[VIDEO LOSE]

- Turn on/off the beep at the video lose.

### 4.[ALARM ACTIVE]

- Turn on/off the beep when an alarm is triggered.

### 5.[MOTION DETECT]

- Turn on/off the beep when motion is detected.

1. When the buzzer is triggered to beep, press any button on the front panel to turn off the Beep.
2. The beeping can only be turned off manually. There is no time out setup to turn off the Beeping automatically.



# JPEG2000 Stand alone DVR User Guide

## 4-3-8 Password setup

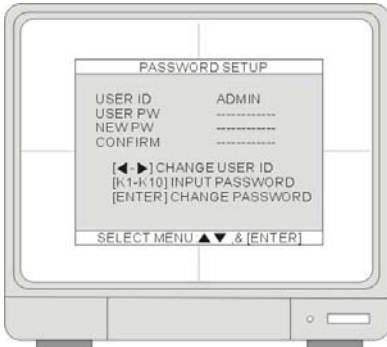

The password consists of 1 to 8 digits. Press the number keys on the front panel to enter the password and you can use any combination of the numbers from 1 to 10.

### 1.[USER ID]

- Press ◀ or ▶ to set User ID.

### 2.[USER PW]

- Key in the current password.

### 3.[NEW PW]

- Key in the new password.

### 4.[CONFIRM PW]

- Enter the new password again for confirmation.

Default password:

ADMIN: (NULL) / MANAGER: "1" / USER1: "2" ~ USER8: "9"

The three user levels have different authorities to operate the DVR.

	Change Settings	Clear HDD	Change Password	Playback & Search	Remote Access
<b>Admin</b>	○	○	○	○	○
<b>Manager</b>	○	×	○※	○	×
<b>User</b>	○	×	×	○	×

※It can change Manager 's and Users' password.

## 4-3-9 System information



Indicate the system information and its status.

- S/W version: Indicate the firmware version  
H/W version: Indicate the PCB version  
Product ID: Indicate the product ID number  
MASTER: Indicate the information of MASTER HDD  
SLAVE: Indicate the information of SLAVE HDD  
CD-R: Indicate the information of CD-R

The product ID is not the DVR's MAC address. MAC address can be found in [EXTERNAL DEVICE] > [TCP/IP setup].

## 4-4 Record setup

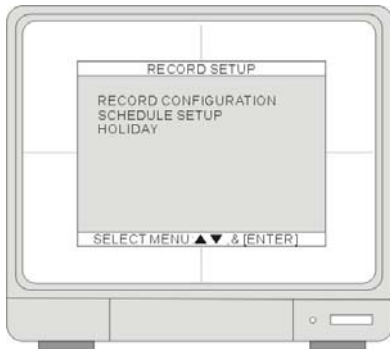

### 1.[RECORD CONFIGURATION]

- Set up overwrite, recording mode, picture quality, resolution, and recording speed.

### 2.[SCHEDULE SETUP]

- Program the recording schedule.

### 3.[HOLIDAY SETUP]

- Set up holidays, max. 100 days.

## 4-4-1 Record configuration



Use [UP] and [DOWN] to select an item. Use [+] and [-] to change the value.

### 1.[OVERWRITE]

- ON: When the hard drive is full, the system will overwrite the earliest recorded data. If the DVR has two hard drives, the overwriting starts from the Master drive.

OFF: The system stops recording when the hard drive is full. If the DVR has two hard drives, the system stops recording when the Master and Slave drive both are full.

### 2.[MULTIPLEX]

- Set up the multiplex mode
- Duplex: allow record and remote connection simultaneously. The DVR stops recording while the DVR enters playback either locally or remotely.  
✳**During the remote connection, the DVR keeps recording if the client stays at the LIVE mode. It stops recording when the client enters the playback mode.**

Triplex: record and playback simultaneously. The DVR keeps recording while the DVR enters playback either locally or remotely.

Under the Triplex mode, you may see the playback is slower than it is under the Duplex mode. The DVR uses the same component to process recording and the playback. As a result, the recording and the playback speed drop by 50% when the DVR enters playback under the Triplex mode.

### 3.[QUALITY]

- Set up the recording picture quality
- Quality level:

4CH: Low / Mid / High / Super / Hyper

8CH and 16CH: Basic / Normal / Enhanced / Fine / Super Fine.

# JPEG2000 Stand alone DVR User Guide

## 4.[RESOLUTION]

- By lowering the resolution, the DVR gains the recording speed but the recorded pictures become smaller.

	Video system	Full Mode	Dual Mode	Quad Mode
<b>4CH</b>	NTSC	60IPS@720*240	120IPS@360*240	240IPS@360*120
	PAL	50IPS@720*288	100IPS@360*288	200IPS@360*144
<b>8CH</b>	NTSC	120IPS@720*240	240IPS@360*240	480IPS@360*120
	PAL	100IPS@720*288	200IPS@360*288	400IPS@360*144
<b>16CH</b>	NTSC	120IPS@720*240	240IPS@360*240	480IPS@360*120
	PAL	100IPS@720*288	200IPS@360*288	400IPS@360*144

※IPS is referred to field per second.

1. Changing the RESOLUTION will NOT change the recording time on DVR.
2. To change the DVR's recording duration, please adjust the DVR's recording speed in the following three settings.

## 5.[RECORD IN ALARM]

- Set the recording speed when an alarm is triggered.

## 6.[RECORD IN MOTION]

- Set the recording speed when motion is detected.

## 7.[CONTINUOUS RECORD]

- Set the recording speed under the continuous recording mode.

1. The recording speed is expressed in fractions. 1/1 is to record at the full recording speed, which you set in RESOLUTION. 1/2 is to record at half of the recording speed. 1/3 is to record at one third of the recording speed. You can set up the parameter from 1/1, 1/2, 1/3, 1/4, ... to 1/999.
2. By lowering the recording speed, the DVR records less frames but gains a longer recording duration. If you set the DVR's recording speed at 1/2, the recording duration will be two times longer. 1/3 will make the recording duration three times longer, and so on.
3. When the RESOLUTION is set to QUAD Mode, the selection of the recording speed is limited to 1/1, 1/2, and 1/3.
4. All active cameras share the recording speed. To turn off the recording on a specific channel, please refer to [SYSTEM MENU] ► [CONFIGURATION] ► [CAMERA SETUP] ► [CAMERA ACTIVE SETUP]. Please note that channels with video loss are still active and recording. In other words, those channels are still sharing the recording speed.

# JPEG2000 Stand alone DVR User Guide

## 4-4-2 Schedule record

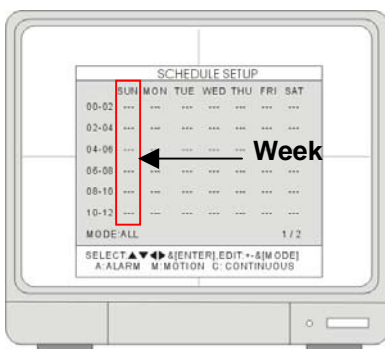
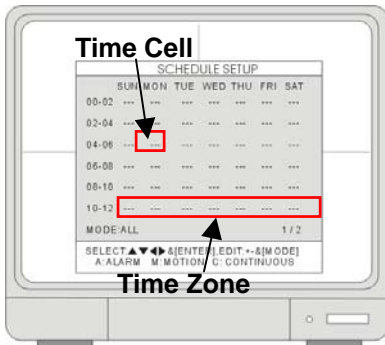

Program a recording schedule throughout the year.

- **MODE:** Press MODE to select an editing mode. Use the direction keys ◀ ▶ ▲ ▼ to move the cursor, and then press [+] and [-] to select a recording mode.

The editing modes are as below:

**TIME CELL:** Program the schedule at a two-hour interval.

**TIME ZONE:** Program the schedule by time zone. There are 12 Time Zones in the setting. A time zone is a two-hours interval from Sunday to Saturday.

**WEEK:** Program the schedule day by day.

**ALL:** The DVR records at one recording mode, 24 hours a day, 7 days a week.

**CLEAR ALL:** Clear all the schedule settings

- **NEXT:** Go to the next page. The first page is from 00-12, and the second page is from 12-24.
- Set up a recording mode:

**A-** ALARM REC / **M-** MOTION REC / **C-** CONTINUOUS REC

---: No schedule recording

**A--:** Set as Alarm record. When there is an alarm triggered, the DVR records at the speed set in RECORD IN ALARM.

**-M-:** Set as motion record when there is motion detected, the DVR records at the speed set in RECORD IN MOTION.

**--C:** Set as continuous record. The DVR records continuously at the speed set in CONTINUOUS RECORD.

**AM-:** Set as Alarm+Motion record. The DVR records at the speed set in RECORD IN ALARM when there is an alarm triggered, and at the speed set in RECORD IN MOTION where there is motion detected.

**A-C:** Set as Alarm+Continuous record. The DVR records continuously at the speed set in CONTINUOUS RECORD, and switches to the speed set in RECORD IN ALARM when there is an alarm triggered.

**-MC:** Set as Motion+ Continuous record. The DVR records continuously at the speed set in CONTINUOUS RECORD, and switches to the speed set in RECORD IN MOTION when there is motion detected.

1. If the DVR is set to MOTION RECORDING and the DVR keeps recording continuously or is not triggered to record as you expect, please check the sensitivity settings and the motion mask setup in CONFIGURATION > CAMERA SETUP > MOTION SETUP.
2. If the motion settings are too sensitive, you may want to lower the sensitivity level and define a motion detection area for more accuracy. If the motion is not triggered as your expectation, you may want to increase the sensitivity level, clear the motion mask, or enlarge the detection area.

# JPEG2000 Stand alone DVR User Guide

## 4-4-3 Holiday setup



Set up the holidays through out the year. You can program up to 100 days as holidays. The recording schedule of the holidays is the same as the settings of Sunday.

- Press MODE and set the editing mode as EDIT HOLIDAY. Use direction key ▲ ▼ ◀ ▶ to select and press ENTER to mark the day as a holiday.
- To clear the settings, press MODE to set the editing mode to CLEAR ALL DATA or CLEAR MON DATA (clear data month by month). Press ENTER to clear the settings.

## 4-5 Back-up

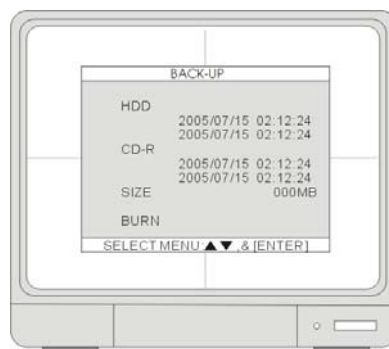
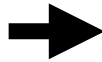
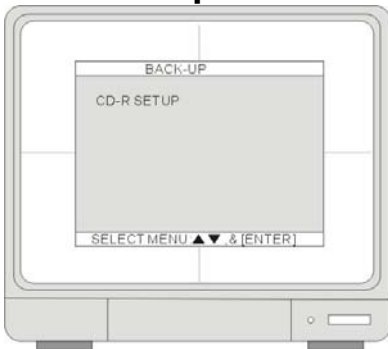

### 1.[HDD]

- Indicate the start and the end recording date and time of the HDD(s).

### 2.[CD-R]

- Select a starting date and time for backup. Press ENTER and use ▲ ▼ to move the cursor. Use [+] [-] or J.Shuttle to change the value. Press ENTER and then press ▼ go to SIZE to choose a backup size.

### 3.[SIZE]

- Insert a blank CD disk and the DVR will check the disk size and displays on the screen. Press ENTER to enter the SIZE selection. Use [+] [-] or J.Shuttle to change the value. Press ENTER and the DVR calculates the end date and time for backup automatically.

### 4.[BURN]

- Move the cursor to BURN and press ENTER to start the backup. System will save the file in **AJP** format. Users have to install the program of CD-R BACKUP PLAYER to playback the backup file. Please refer to CHAP.5 CD-R Back-up for more details.

1. Use a blank CD. Do not format or reuse a CD even though it is rewritable.
2. When choosing a backup size, leave 20MB as a buffer and do not use the full space of a CD.
3. Once the DVR starts burning CD, do not press any button to stop the process. When the burning is completed, the DVR ejects the CD automatically.

# JPEG2000 Stand alone DVR User Guide

## 4-6 External device

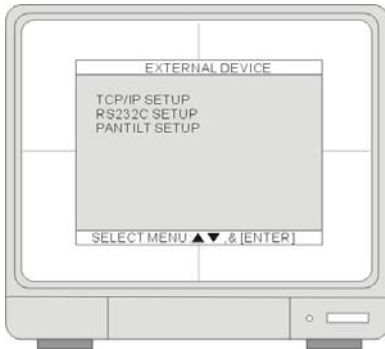

- 1.[TCP/IP SETUP]
  - Set up the DVR's TCP/IP information.
- 2.[RS232C SETUP]
  - Set up the parameters of the RS232 port.
- 3.[PANTILT SETUP]
  - Set up the parameters of the PTZ control.

### 4-6-1 TCP/IP setup

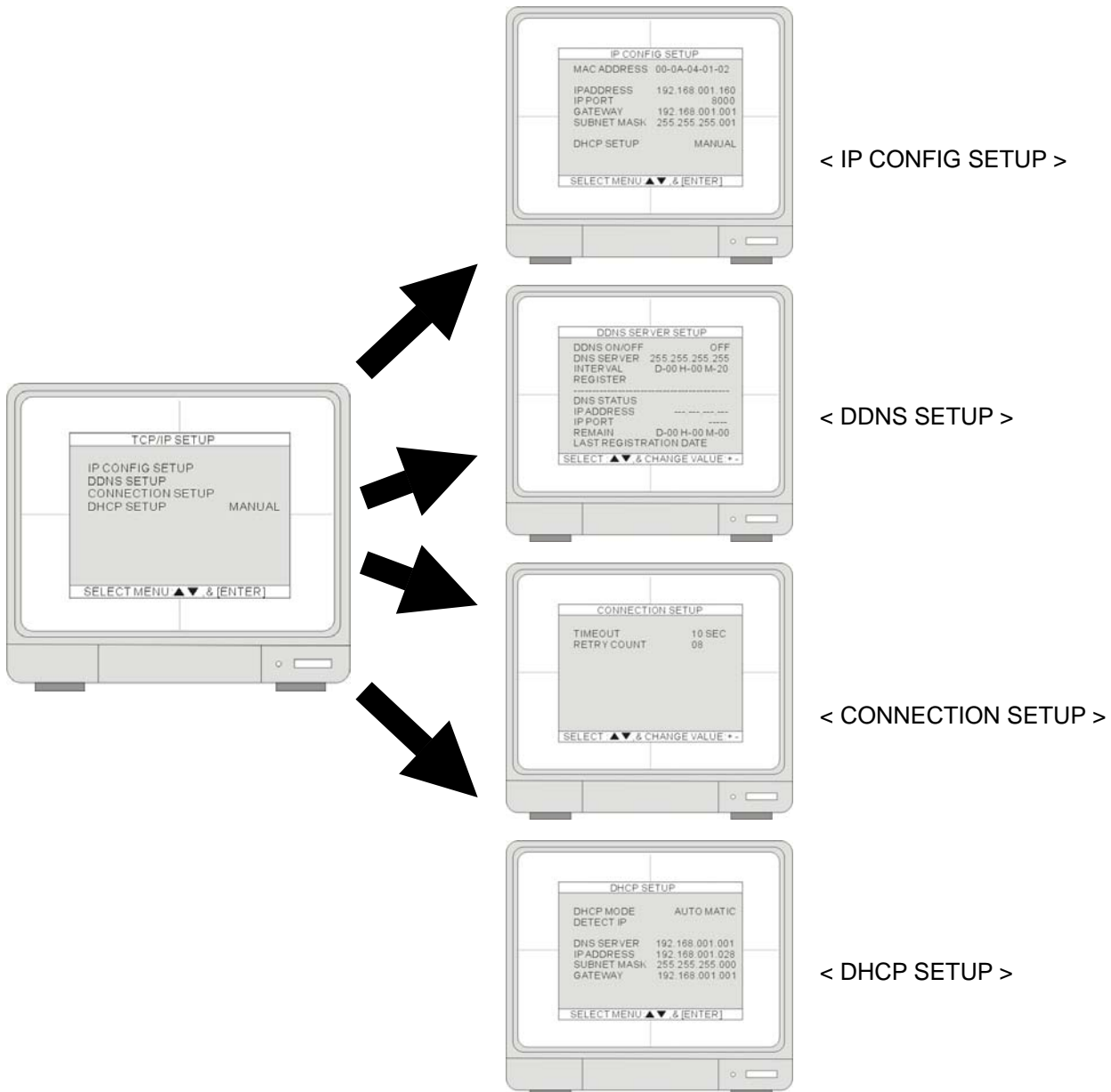

# JPEG2000 Stand alone DVR User Guide

## [IP CONFIG SETUP]

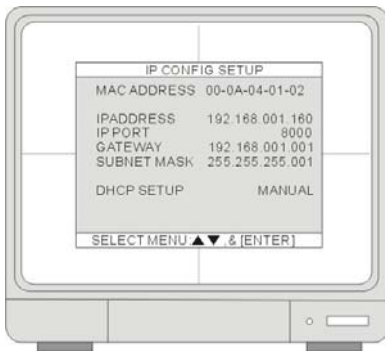

Press ENTER to enter a selection. Use ▲ ▼ to move the cursor. Use [+] [-] or J.Shuttle to change the value, and press ENTER to confirm the setting and exit the selection. Use ▲ ▼ to go to another selection and repeat the previous steps.

### 1.[MAC ADDRESS]

- Indicate the DVR's MAC address. MAC address is not editable.

### 2.[IP ADDRESS]

- Set up the DVR's IP address.

### 3.[IP PORT]

- Set up IP Port.

### 4.[GATEWAY]

- Set up GATEWAY.

### 5.[SUBNET MASK]

- Set up SUBNET MASK.

### 6.[DHCP SETUP]

- Inditcate the DHCP mode is set to Manual or Automatic. When DHCP is set to Automatic, you can not change any IP settings in this page. To turn off the DHCP automatic detection, exit this page and go to DHCP SETUP to change the setting.

## [DDNS SETUP]

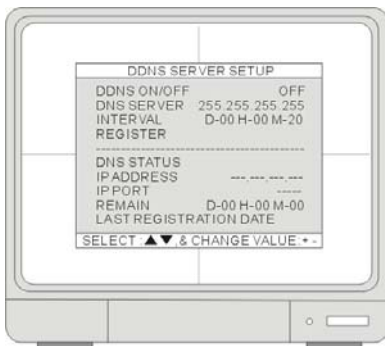

### 1.[DDNS ON/OFF]

- Press ENTER to turn ON and OFF the function.

### 2.[DNS SERVER]

- Set up DNS Server's IP address. Press ENTER to enter the selection. Use ▲ ▼ to move the cursor and [+] [-] or J.Shuttle to change the value. Press ENTER to confirm the settings and exit the selection.

### 3.[INTERVAL]

- Set up an interval for the DVR to report its IP address to the DDNS server automatically. (D- day / H- hour / M- minute). Press ENTER to enter the selection and [+] [-] or J.Shuttle to change the value. Press ENTER to confirm the settings and exit the selection.

### 4.[REGISTER]

- Connect to DDNS server and register the DVR information to the server. Press ENTER to start the registration.

### 5.[DNS STATUS]

- Indicate the current status of DDNS connection

**IP ADDRESS:** Indicate the current IP address recorded in the server

**IP PORT:** Indicate the current IP port recorded in the server.

**REMAIN TIME:** Indicate the remaining time to report to the server.

### 6.[LAST REGISTRATION DATE]

- Indicate the time of the last registration.

DDNS IP: 59.124.143.151

# JPEG2000 Stand alone DVR User Guide

## [CONNECTION SETUP]

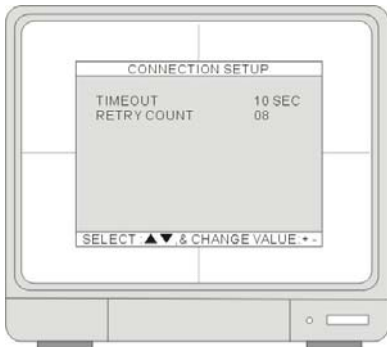

Use ▲ ▼ to select and [+] [-] or J.Shuttle to change the value.

### 1.[TIMEOUT]

- Set up the remote connection response time, if the client does not receive responses from the DVR for certain duration, the client will disconnect the connection and try again. The setup range is from 1 millisecond to 12,750 seconds.

### 2.[RETRY COUNT]

- Set up the times that the client tries to reconnect to the DVR. The client will quit trying to reconnect to the DVR after all the attempts fail. The setup range is from 0 to 20 attempts.

## [DHCP SETUP ]



### 1.[DHCP MODE]

- Press ENTER to switch DHCP to [AUTOMATIC].

### 2.[DETECT IP]

- Move the cursor to DETECT IP and press ENTER to start. Press MENU to cancel the detection.

## 4-6-2 RS232C setup

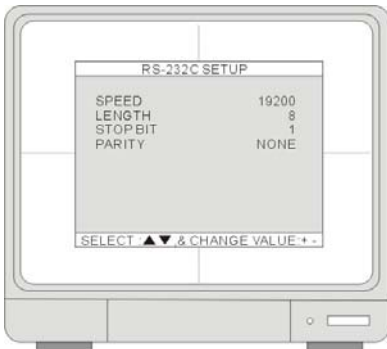

Through the RS232 port, users can connect the DVR to a PC or other control devices to control the DVR. The ASCII-Code information is in **CHA.2, Serial port setup**. Users cannot change value in this setting.

### 1.[SPEED]

- The transmission baudrate is 19200bps.

### 2.[LENGTH]

- The transmission length is 8 bits.

### 3.[STOP BIT]

- The stop bit is 1.

### 4.[PARITY]

- The parity is none.



# JPEG2000 Stand alone DVR User Guide

## 4-6-3 Pantilt setup

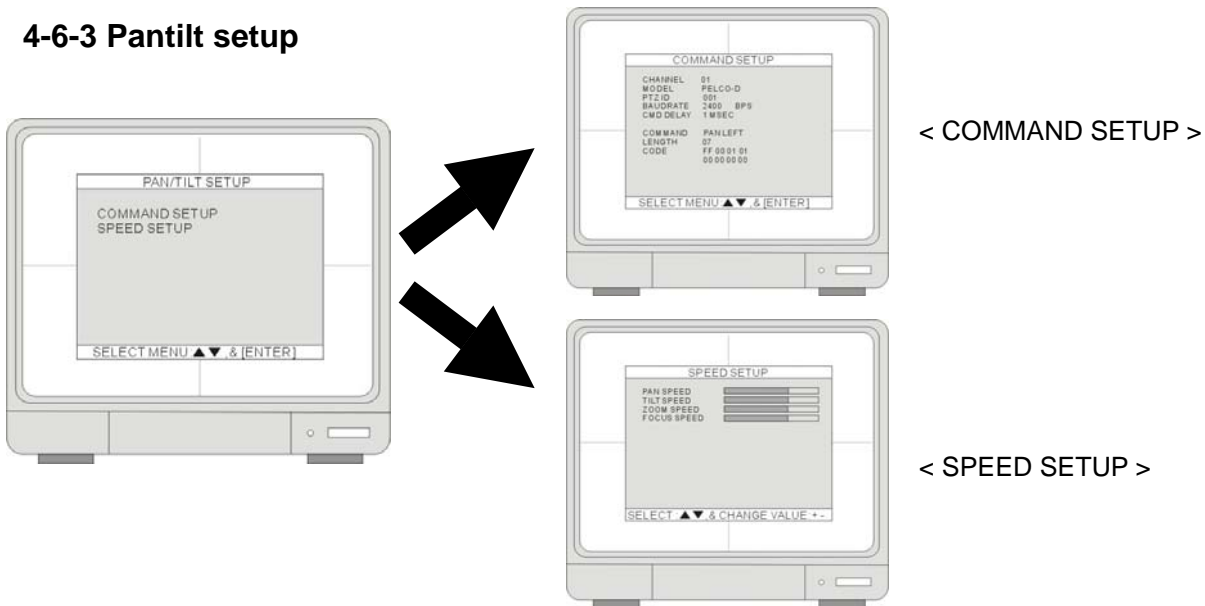

### [COMMAND SETUP]

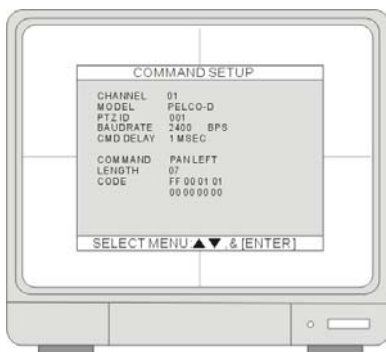

Press ▲ ▼ to select and [+] / [-] to change the value.

#### 1.[CHANNEL]

- Select PTZ channel.

#### 2.[MODEL]

- Select PTZ protocol.

#### 3.[PTZ ID]

- Select PTZ ID.

#### 4.[BUADRATE]

- Select Baud Rate of PTZ control code.

#### 5.[CMD DELAY]

- Set up a delay time to run the command.

#### 6.[COMMAND]

- Pick up PTZ CMD.

#### 7.[LENGTH]

- Set up the length of PTZ control code.

#### 8.[CODE]

- The control code of PTZ CMD.

Please refer to **CHAP.6 PTZ Camera Control** for more details.

# JPEG2000 Stand alone DVR User Guide

## [SPEED SETUP]

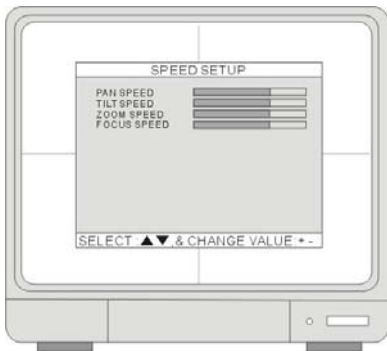

Press ▲ ▼ to select and [+] / [-] to change the value.

### 1.[PAN SPEED]

- Set the PANing speed.

### 2.[TILT SPEED]

- Set the TILTING speed.

### 3.[ZOOM SPEED]

- Set the speed of ZOOM IN/OUT.

### 4.[FOCUS SPEED]

- Set the speed of FOCUS NEAR/FAR.

## 4-7 Factory default

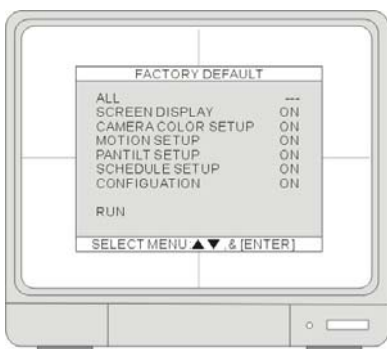

Press ▲ ▼ to select and ENTER to turn ON and OFF the selection. Move the cursor to RUN and press ENTER to execute the Factory Default.

### 1.[ALL]

- Set all the settings back to factory default.

### 2.[SCREEN DISPLAY]

- Set "SCREEN DISPLAY" back to factory default.

### 3.[CAMERA COOLR SETUP]

- Set "CAMERA COLOR SETUP" back to factory default.

### 4.[MOTION SETUP]

- Set "MOTION SETUP" back to factory default.

### 5.[PANTILT SETUP]

- Set "PANTILT SETUP" back to factory default.

### 6.[SCHEDULE SETUP]

- Set "SCHEDULE SETUP" back to factory default.

### 7.[CONFIGURATION]

- Set "CONFIGURATION" back to factory default.

1. The DVR cannot reset the password to default by running Factory Default.

2. It is strongly suggested to run Factory Default and HDD CLEAR when you install a new hard drive(s).

## 4-8 Language

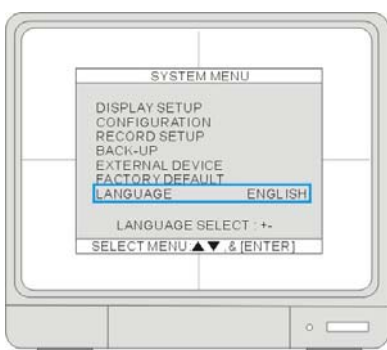

- Press [+] / [-] button to select a language.

## CHAP.5 CD-R Back-up

### 5-1 Data backup

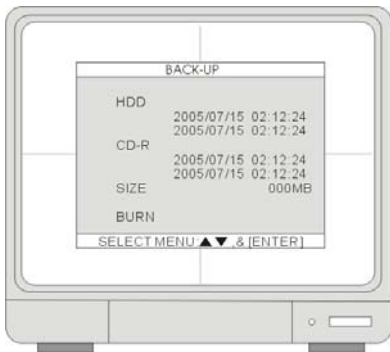

#### 1.[HDD]

- Indicate the start and the end recording date and time of the HDD(s).

#### 2.[CD-R]

- Select a starting date and time for backup. Press ENTER and use ◀ ▶ to move the cursor. Use [+] [-] or J.Shuttle to change the value. Press ENTER and then ▼ to go to SIZE to choose a backup size.

#### 3.[SIZE]

- Insert a blank CD disk and the DVR will check the disk size. Press ENTER to choose a backup size. Use [+] [-] or J.Shuttle to change the value. Press ENTER and the DVR calculates the end date and time for backup automatically.

#### 4.[BURN]

- Move the cursor to BURN and press ENTER to start the backup. System will save the file in **AJP** format. Users have to install the program of CD-R BACKUP PLAYER to playback the backup file on a PC.

1. Use a blank CD. Do not format or reuse a CD even though it is rewritable.
2. When choosing a backup size, leave 20MB as a buffer and do not use the full space of a CD.
3. Once the DVR starts burning CD, do not press any button to interrupt the process. When the burning is completed, the DVR ejects the CD automatically.

# JPEG2000 Stand alone DVR User Guide

## 5-2 CD Player software installation



1. Insert software CD.
2. Click **[Install CD-R backup player]** to start the installation.

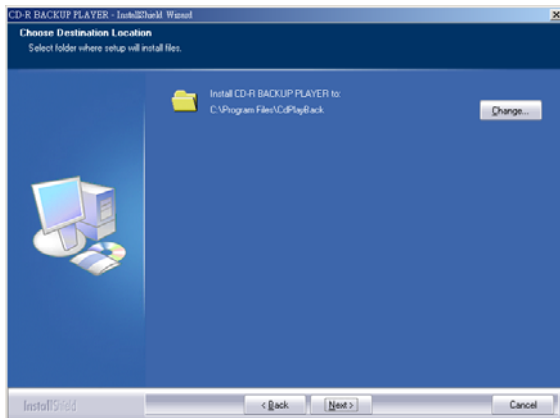

3. Select a Destination Folder

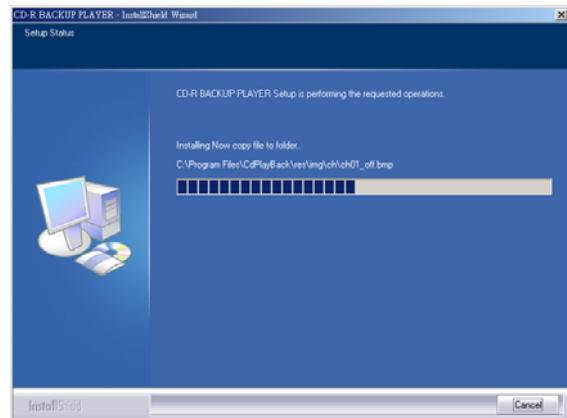

4. Copy files to the Destination Folder.  
System will build a new icon of **[CD BACKUP PLAYER]** on PC **[DESKTOP]**.  
Double click the icon of CD Backup Player from Desktop to run the program.

# JPEG2000 Stand alone DVR User Guide

## 5-3 CD Player software interface

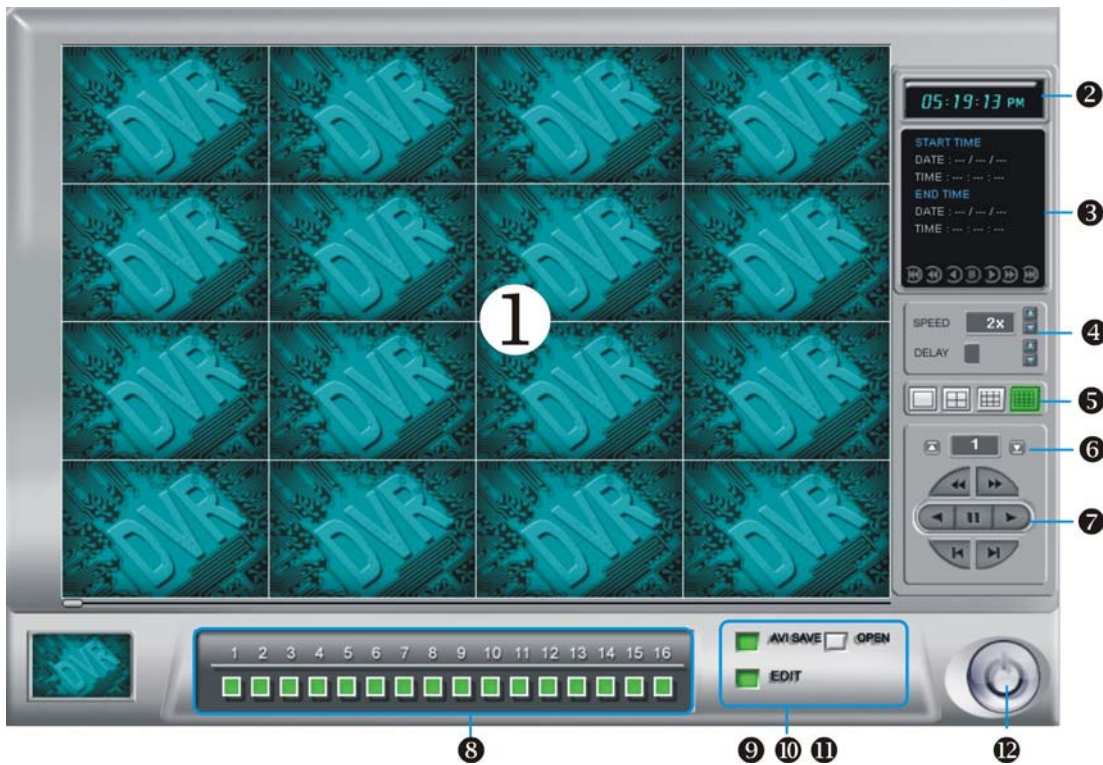

1. Display screen: To display the backup image

2. Time display: To indicate the current time

3. Information window: To indicate the CD's start/end time and date, and the backup video quality (resolution).

4. Speed Adjustment:

Speed: Select a playback speed (2X, 4X, 8X, 16X, 32X, 64X) and press for Fast Rewind and for Fast Forward

Delay: Select a speed to play in slow motion (1/2X, 1/4, 1/8X, 1/16X) and press for Rewind and for Forward

5. : Select a [1 / 4 / 9 / 16] Screen display

6. : Go to the next page : Go to the previous page

7. Function button:

	Fast Rewind		Fast Forward
	Rewind		Forward
	Pause		
	To the beginning		To the end

8. Channel selection: To select a single channel from CH1 to CH16

9. AVI SAVE: To save the backup video to AVI format

10. EDIT: To open the dialog window to save a single frame as a JPEG file or print it out.

11. OPEN: To open the backup file from CD-R

12. EXIT: To exit the program

# JPEG2000 Stand alone DVR User Guide

## ➤ Open AJP file

1. Select **(OPEN)** and the window below will show up on the screen.

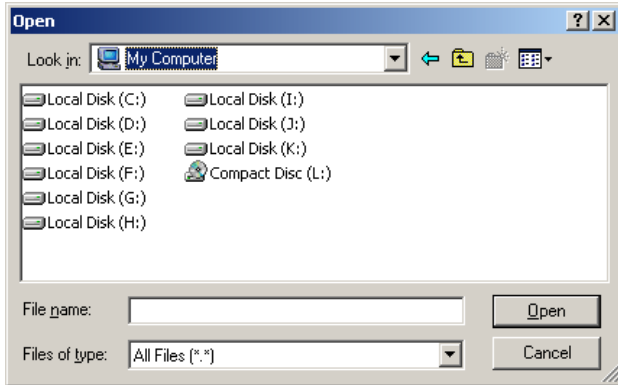

2. Select the file and click **[OPEN]** to open the AJP file.

## ➤ Save JPG file

1. During playback and under FULL SCREEN MODE, when you see the picture you want to save, click EDIT.

2. Select **[SAVE]** to save the picture as JPEG file or select **[PRINT]** to print the image.



❶ To save single picture as JPG file.

❷ To print the picture.

❸ To exit the EDIT mode.

## ➤ Save as AVI file

During playback, you can save the backup file to AVI format.

1. Open the backup file from CD-R, playback to where you want to start saving the AVI file. Select **[AVI SAVE]** to open the AVI SAVE dialog window.

2. Select the channel, frame rate, and AVI image size.

3. Select "START" to save and "END" to stop the process.

4. Click **[AVI SAVE]** again to close the AVI SAVE dialog window.

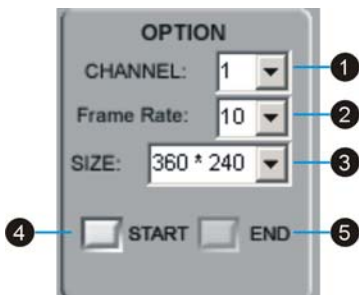

❶ CHANNEL: Select a channel to save

❷ Frame Rate: Select how many frames to save every second

❸ SIZE: Set the resolution as 360\*240 or 720\*480

❹ START: Start saving AVI file

❺ END: Stop saving AVI file

## CHAP.6 PTZ camera control

### 6-1 PTZ camera Installation

#### 6-1-1 Connection Setup

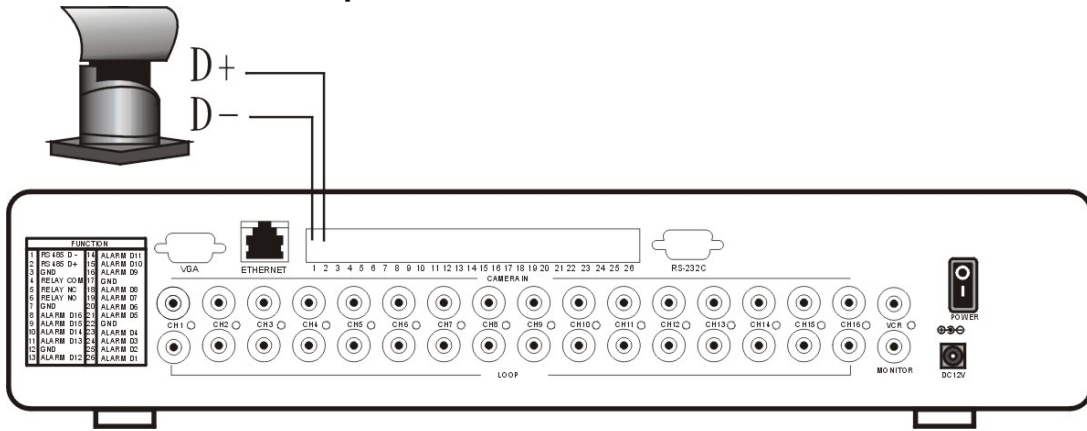

- Connect the PTZ's D+ to the DVR's D+, and D- to D-.

#### 6-1-2 PTZ setup

Each PTZ manufacturer may have different transmission baud rate. Please refer to the PTZ manuals for the detail information. Enter the baud rate suggested by the manufacturer in the DVR's PTZ setup.

#### [EXTERNAL DEVICE]



- SYSTEM MENU ▶ EXTERNAL DEVICE ▶ PANTILT SETUP ▶ COMMAND SETUP

1. **[MODEL]:** select a PTZ protocol.
2. **[PTZ ID]:** enter the PTZ's ID / address.
3. **[BAUD RATE]:** enter the PTZ's transmission baud rate
4. **[CMD DELAY]:** the delay time of the command transmission between bytes. Please refer to the PTZ user manual for the manufacturer's suggestion.

# JPEG2000 Stand alone DVR User Guide

## 6-2 PTZ camera operation

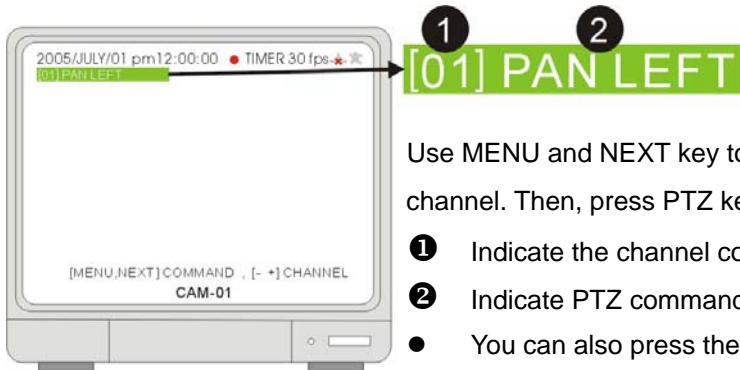

Use MENU and NEXT key to select a PTZ command, and [+] [-] to select the channel. Then, press PTZ key to enter the PTZ control mode.

- ❶ Indicate the channel connected with a PTZ camera.
- ❷ Indicate PTZ command, press ENTER to send control code by PTZ key.
- You can also press the PTZ button on the front panel, and use the front panel pre-assigned PTZ function keys to control the PTZ camera.

### [Operate by PTZ control keys]

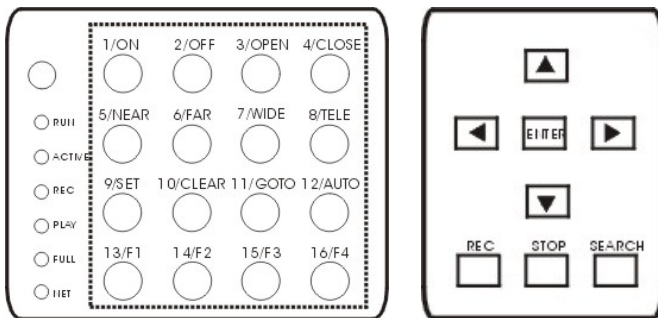

- After entering PTZ control mode, PAN/TILT function can be controlled by direction keys and pre-assigned PTZ function keys. .



## CHAP.7 Network and client software

### 7-1 Network Introduction

- Users have to identify what kind of Internet access they have before they set up the DVR's network parameters. DSL and cable modem are the most popular broadband technologies.
- ADSL- Asymmetric Digital Subscriber Line  
ADSL is one of xDSL technologies, transmitting digital data over the wires of a local telephone network. Typically, the download speed of DSL ranges from 128 kilobits per second (kbit/s) to 24,000 kbit/s depending on DSL technology and service level implemented. Upload speed is lower than download speed. ADSL is the most popular broadband technology, followed by Cable Modem.
- Cable Modem(or Cable)  
Cable Modem, Cable Internet Access, or simply Cable is to deliver the Internet Service over a coaxial cable line, which can be the cable of your Cable TV. The bandwidth of Cable ranges from 3 Mb to 15 Mb, or more. The upload bandwidth usually ranges from 384kb to 2Mb, or more. However, the connection speed may drop when many people are using the service at the same time

### 7-2 Network installation and setup

#### 7-2-1 Via Cable

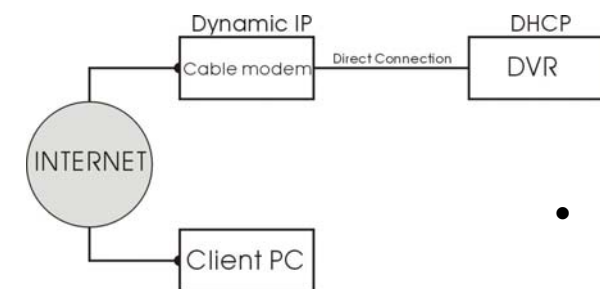

- Connect the Network cable of Cable Modem output to DVR

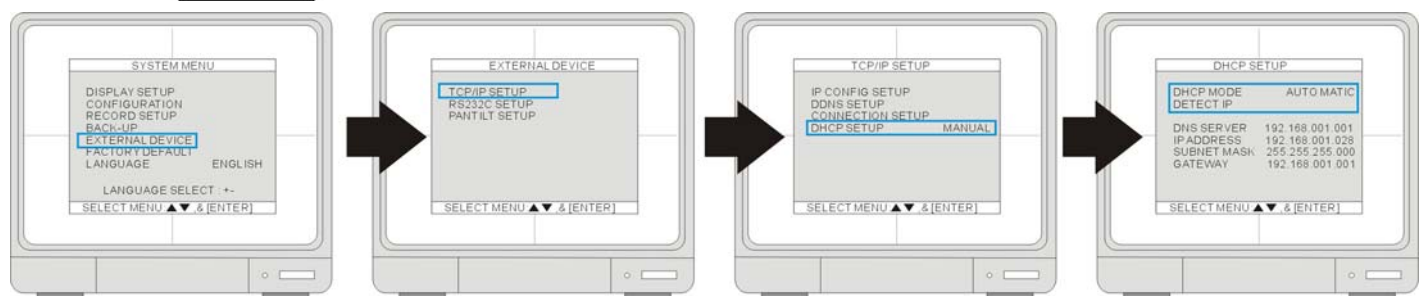

- Enter [SYSTEM MENU] ► [EXTERNAL DEVICE] ► [TCP/IP SETUP] ► [DHCP SETUP] ► [DHCP MODE]. Place the cursor at DHCP MODE and press ENTER to switch the DHCP MODE to [AUTOMATIC]. Then, move the cursor over [DETECT IP] and press ENTER to detect IP. DVR will automatically get the IP ADDRESS, SUBNET MASK, and GATEWAY from the Cable Modem and shows the IP information on the DVR.
- Press MENU and go back to the previous setup page, [TCP/IP SETUP]. Go to [IP CONFIG SETUP] to set up the port number. You can either use the default port number or assign a new one.

# JPEG2000 Stand alone DVR User Guide

## 7-2-2 Via ADSL

- First, identify if you have Static IP or Dynamic IP service. If you do not know, ask your ISP (Internet Service Provider). If you have Static IP, your ISP should provide you a static IP address, which will never change even when you reboot your modem.

[Via ADSL with Static IP address]

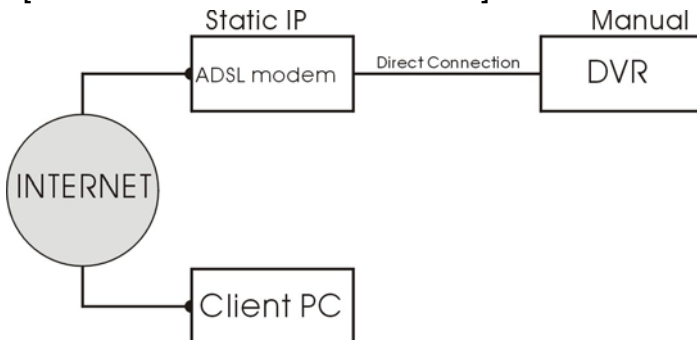

- Connect the Network cable of Cable Modem output to DVR

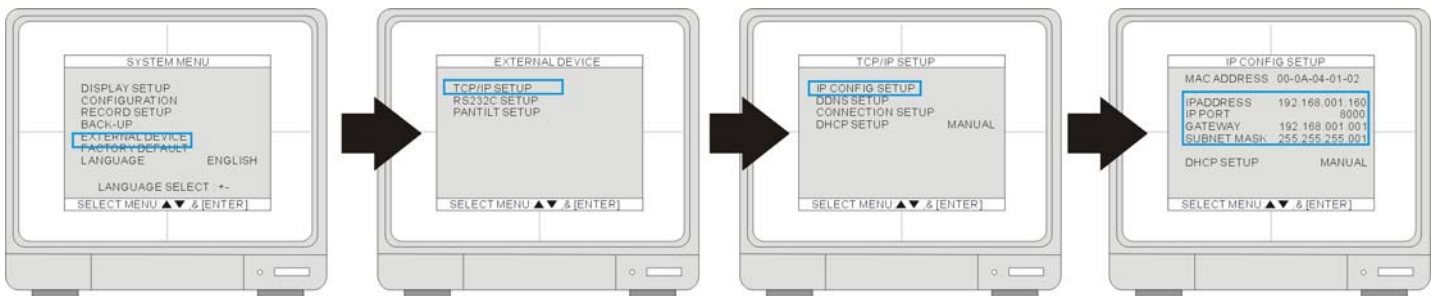

- Enter [SYSTEM MENU] ► [EXTERNAL DEVICE] ► [TP/IP SETUP] ► [IP CONFIG SETUP]. Enter the IP address, gateway, subnet mask provided by your ISP. Then, assign a port number to the DVR, or you can use the default one as well.
- If you find that you cannot enter or change any addresses, check if DHCP is set to Automatic. Press MENU to go back to the previous page, [TCP/IP Setup], and then enter [DHCP SETUP]. Select DHCP MODE and press ENTER to switch DHCP to MANUAL
- In some very rare cases, we found the DVR did not support certain Static IP Addresses. If it happens, add a Router to the network system. The setup is the same as the next session, [Via ADSL with Dynamic IP.]

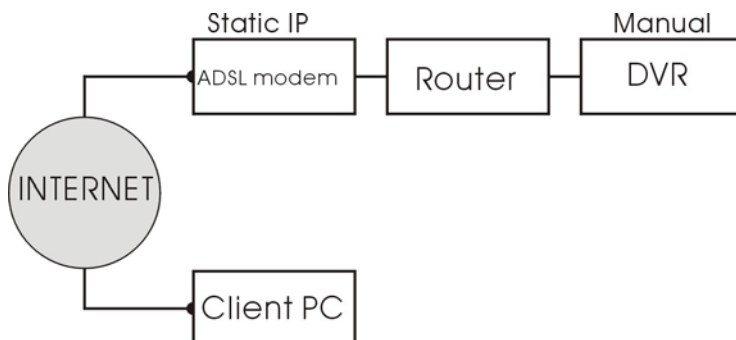

# JPEG2000 Stand alone DVR User Guide

[Via ADSL with Dynamic IP]

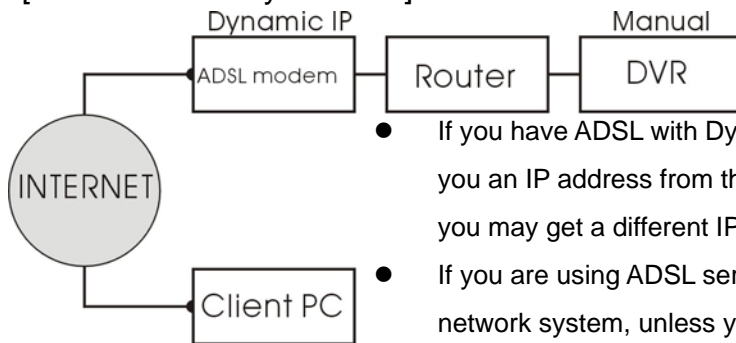

- If you have ADSL with Dynamic IP address, the network administrator assigns you an IP address from their pool when you or your ISP reboots the network and you may get a different IP address from time to time.
- If you are using ADSL service with Dynamic IP, you must add a Router in the network system, unless your DSL MODEM has a built-in Router.

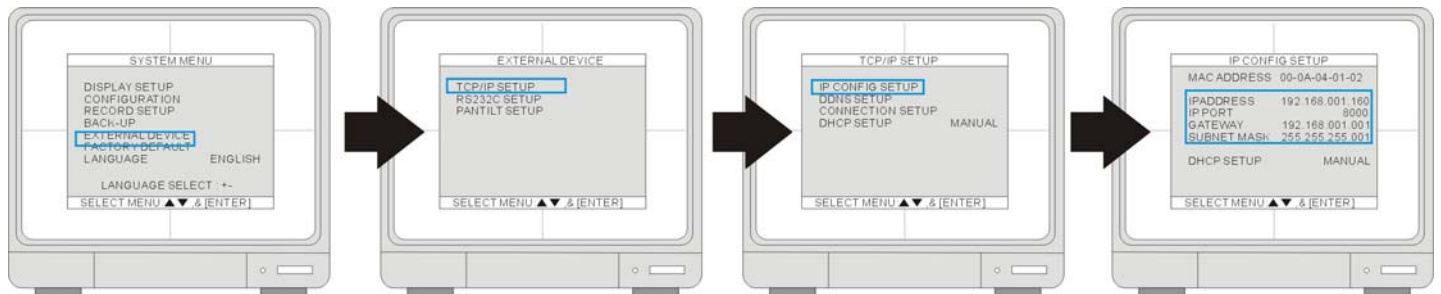

- Go to [EXTERNAL DEVICE] ► [TCP/IP SETUP] ► [IP CONFIG SETUP] to enter the virtual IP address for the DVR and the IPs of gateway and subnet mask. Then, assign a port number to the DVR or you can use the default port number as well.
- If you find that you cannot enter or change any addresses, check if DHCP is set to Automatic. Press MENU to go back to the previous page, [TCP/IP Setup] and then enter [DHCP SETUP]. Select DHCP MODE and press ENTER to switch DHCP to MANUAL
- The Gateway IP is your router's IP address and the Subnet Mask should match the Subnet Mask IP of your router.

Tip: If you have other computers connected to the router, you can find out the Subnet Mask and Gateway information from the computers. From the computer desktop's Start Menu, choose Run. Type "cmd" to open a command prompt. In this command prompt, type "ipconfig" and hit "ENTER" and it'll show the computer's IP configuration. Your DVR should have the same IP configuration of Subnet Mask and Gateway as the computer, if they are connected to the same router. In addition, the first 3 segments of the local IP Address should be the same as well. For example, if your computer's local IP address is 192.168.1.100, your DVR's IP address should be 192.168.1.XXX.

- Set up the router to forward the port to the DVR. Please refer to 7-3 Router Setup for details.
- After the setup is completed and the DVR can be accessed from Internet, proceed to the DDNS setup. Since you may get different IP addresses from time to time, setting up the DDNS service allows you to log in from the remote by using a fixed code name, instead of using the IP addresses that are constantly changing.

# JPEG2000 Stand alone DVR User Guide

## 7-3 Router setup

- There is a wide selection of routers in the market. They may be very different in terms of configuration and operation. Here is an example of how to set up a router. For details, please read your router's manual.

- First, connect a computer to the router for configuration.

In this example, the DVR's IP is set to 192.168.1.53 and its port number is 8000. The router model is PCI BLW-04G.

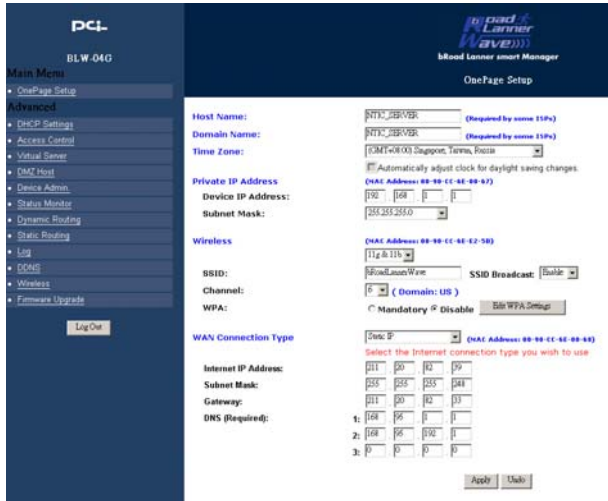

- Enter the router's setup and select Static IP or PPPoE.

### 1. [WAN connection type]

#### [Static IP setup]



#### WAN Connection Type

Internet IP Address:

Subnet Mask:

Gateway:

DNS (Required):

Static IP (MAC Address: 00-90-CC-6E-00-68)

Select the Internet connection type you wish to use

211 . 20 . 82 . 39

255 . 255 . 255 . 248

211 . 20 . 82 . 33

1: 168 . 95 . 1 . 1

2: 168 . 95 . 192 . 1

3: 0 . 0 . 0 . 0

- Select the mode in WAN connection Type
- Enter the static IP Address, Subnet Mask, Gateway, DNS provided by your ISP
- Save the settings.

# JPEG2000 Stand alone DVR User Guide

## [PPPoE setup]



WAN Connection Type:  (MAC Address: 00-90-CC-6E-00-68)  
 Select the Internet connection type you wish to use

User Name:   
 Password:

Fixed IP Address:  Enable  Disable  
 IP Address:  .  .  .

Connect on Demand: Max Idle Time  Min.  
 Keep Alive: Redial Period  Sec.

- Select PPPoE in WAN connection Type
- Enter User Name and Password provided by your ISP
- The router will get the IP address upon connection. In this example, we get the IP address of 211.20.82.39.

## 2. [Virtual server setup]



Ports		TCP	UDP	Redirect IP Address	Enable
1600	1600	<input checked="" type="checkbox"/>	<input checked="" type="checkbox"/>	192.168.1.180	<input checked="" type="checkbox"/>
8000	8000	<input checked="" type="checkbox"/>	<input checked="" type="checkbox"/>	192.168.1.53	<input checked="" type="checkbox"/>
		<input type="checkbox"/>	<input type="checkbox"/>	192.168.1.	<input type="checkbox"/>
		<input type="checkbox"/>	<input type="checkbox"/>	192.168.1.	<input type="checkbox"/>
		<input type="checkbox"/>	<input type="checkbox"/>	192.168.1.	<input type="checkbox"/>
		<input type="checkbox"/>	<input type="checkbox"/>	192.168.1.	<input type="checkbox"/>
		<input type="checkbox"/>	<input type="checkbox"/>	192.168.1.	<input type="checkbox"/>
		<input type="checkbox"/>	<input type="checkbox"/>	192.168.1.	<input type="checkbox"/>
		<input type="checkbox"/>	<input type="checkbox"/>	192.168.1.20	<input type="checkbox"/>

- Enter Virtual Server setup.
- Enter DVR's IP (192.168.1.53) and port number (8000). Enable the port and check both protocols of TCP and UDP. Save the settings before leaving this page.
- Once the routing table is setup, when the client software connects to 211.20.82.39 with PORT 8000, the router will forward the packets to its matching destination, 192.168.1.53, and thus connect the client to the DVR.

# JPEG2000 Stand alone DVR User Guide

## 7-4 Client software

### 7-4-1 Install and setup

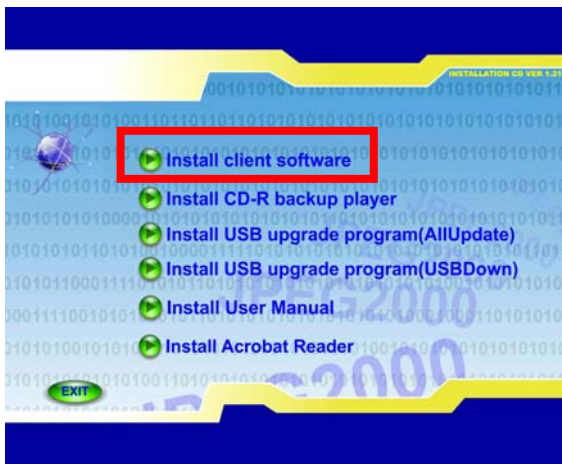

- Insert the Install CD into CD-ROM, and the computer will auto-run the Install program. We suggest installing the software on Windows XP or Windows 2000.

1.[Install Client software]

- Click [Install Client software].

### 7-4-2 Install Client software

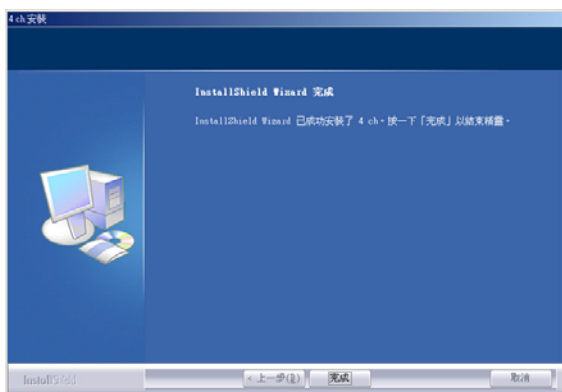
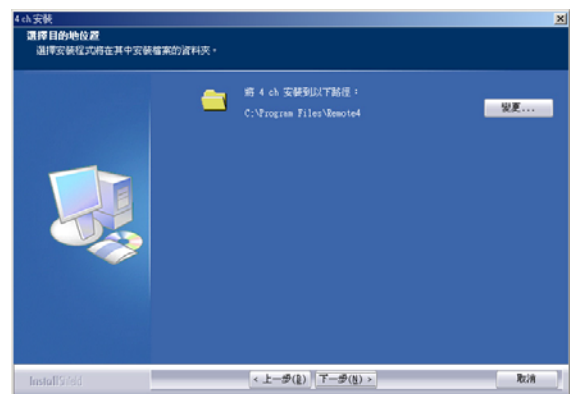

- Select a Destination Folder.
- When finished, the software will create a shortcut on the desktop.
- Click the shortcut to run the client software.

# JPEG2000 Stand alone DVR User Guide

## 7-4-3 Software operation

[Remote viewer interface]

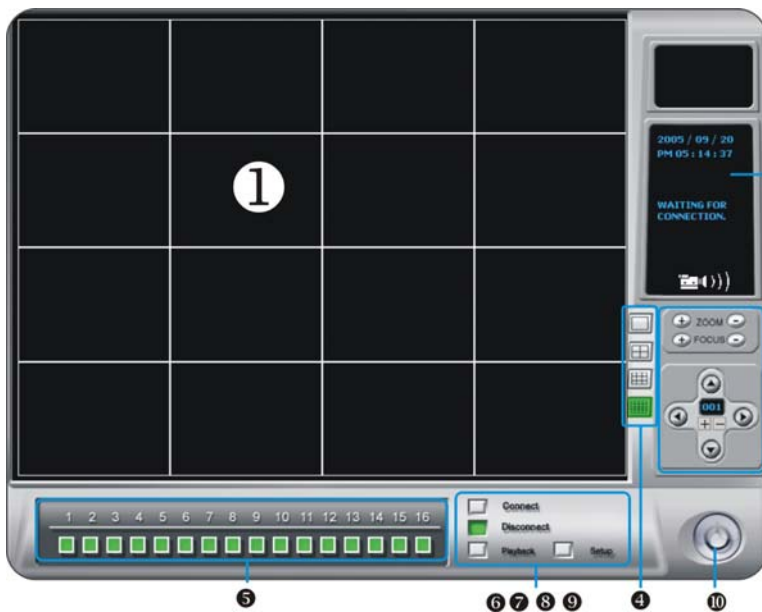

### 1.[Live Display]

- Remote DVR Live display

### 2.[Current Status ]

- To show the current status

### 3.[PTZ Camera Control ]

- To control PTZ Camera  
Zoom/Focus/Direction

#### ※ Remote Control of PTZ:

- 1) Set up PTZ at DVR first
- 2) Set up PTZ from the Client Software

### 4.[Screen Split ]

- To select Full/4/9/16 split screen display

### 5.[Channel Selection ]

- To select CAM1~16 when full or split screen display

### 6.[Connect ]

- To select a DVR IP address from IP list for connection.

### 7.[Disconnect ]

- To disconnect the DVR

### 8.[Playback ]

- To enter playback

### 9.[Setup]

- To enter the setup

### 10.[Power ]

- To close the remote program. The connection to the DVR will break off after the remote software is closed.

# JPEG2000 Stand alone DVR User Guide

## 7-4-4 Client software setup

### [IP/PORT]

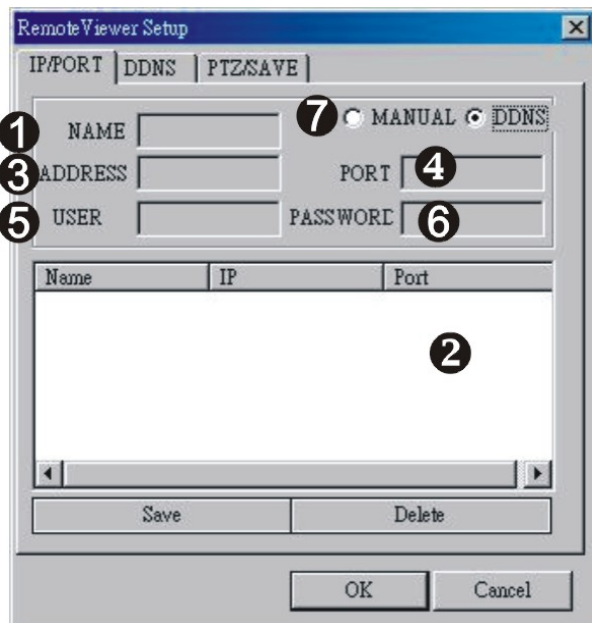

#### 1.[DVR NAME]

- Enter the DVR's location or name

#### 2.[IP LIST]

- Show the list of saved DVR IP addresses. If you are connecting to a DVR in this list, you can simply click it from the list, enter the DVR Admin's password, and press SAVE and then OK. Click CONNECT from Remote Viewer Interface to connect.

#### 3.[IP ADDRESS]

- Enter the DVR's IP address
- If the DVR is connected to a router, you have to enter a real IP address, instead of using a virtue IP address.

#### 4.[PORT]

- Enter the DVR's port number.

#### 5.[USER ID]

- Enter the user ID as "**ADMIN**".

#### 6.[PASSWORD]

- Enter the DVR Admin's password

#### 7.[MANUAL/DDNS]

- If you have static IP address or are not using DDNS service, select MANUAL. If you are using DDNS service, select DDNS and click the tab DDNS on the top and enter DDNS setup page.

※ If you are setting up a new DVR to connect, follow the steps:

1. Enter the DVR's location or name.
2. Enter the DVR's IP address and port number.
3. Enter the user ID as "**ADMIN**" and DVR Admin's password
4. Press SAVE and then OK. Click CONNECT from Remote Viewer Interface

1. How to find out my real IP address: if you have computers connected to the router which the DVR is connected to, you can use your computer and go to <http://www.whatismyip.com> to find out your current IP address.
2. What is virtue IP address: The Internet Assigned Numbers Authority has reserved the following three blocks of the IP address space for private internet (local networks):  
10.0.0.0 - 10.255.255.255  
172.16.0.0 - 172.31.255.255  
192.168.0.0 - 192.168.255.255  
Also, IP addresses in the range of 169.254.0.0 -169.254.255.255 are reserved for Automatic Private IP Addressing. These IP's should not be used on the Internet.



# JPEG2000 Stand alone DVR User Guide

## [DDNS]

Remote Viewer Setup

IP/PORT DDNS PIZ/SAVE

DDNS INFO

1 Group  Save 3

2 DVR Name  Load

DVR INFO

4 IP Address

5 User ID admin Get IP 7

6 Password

OK Cancel

### 1.[Group]

- Enter Group name registered on DDNS Server. Please refer to **7-5 DDNS setup and operation for details.**

### 2.[DVR Name]

- Enter DVR name registered on DDNS Server. If the DVR name is entered and saved before, click LOAD to browse the list.

### 3.[Save/Load]

- Save: Save the setup into the DDNS list
- Load: Open the DDNS list. . Please see the following illustration [DDNS LIST] for details.

### 4.[IP Address]

- Show DVR's current IP address and Port number.

### 5.[USER ID]

- Enter ADMIN

### 6.[PASSWORD]

- Enter the DVR Admin's password

### 7.[Get IP]

- Click "Get IP" to get the current DVR IP address and port number from DDNS server.

8. Click OK and then click CONNECT from Remote Viewer Interface.

## [DDNS LIST]

DDNS Loader

Title	Group	Name
1		

OK 2 Cancel Delete 3

### 1.[DDNS SETUP LIST]

- Show all saved DDNS setup.

### 2.[OK/Cancel]

- Choose a certain setup in the list then click OK or Cancel.

### 3.[Delete]

- Delete a selected item from the list.

# JPEG2000 Stand alone DVR User Guide

## [PTZ/SAVE]

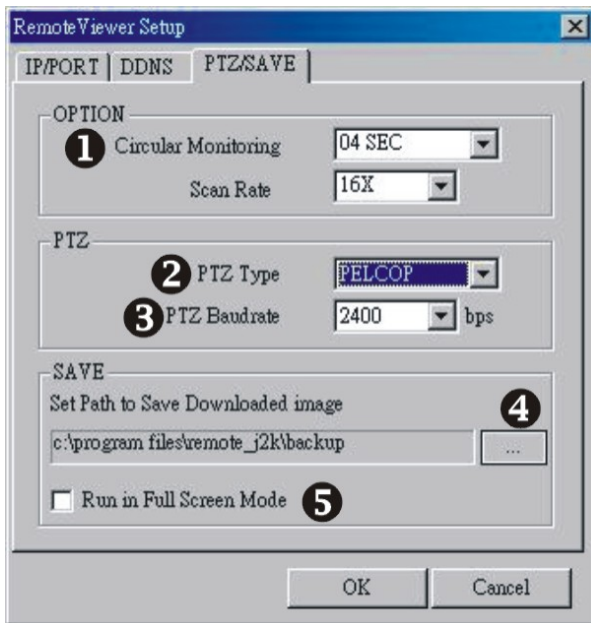

### 1.[Circular Monitoring Interval]

- Set up a sequential switch interval.

### 2.[Scan Rate]

- Select a Fast forward (FF) speed of remote Playback.

### 3.[PTZ Type]

- Select the protocol used by your PTZ camera.

### 4.[PTZ Baudrate]

- Select a PTZ camera baud rate.

### 5.[Set Path to Save Reorded Images]

- Set a path to save the video clips. If you do not specify a path, the program will save all files to its default location, C:\Program Files\Remote\_J2K.

### 6.[Run in Full Screen Mode]

- Check the box to enlarge the Interface to the full computer screen.

## 7-4-5 PTZ control



### 1.[ZOOM]

- Use + / - to adjust PTZ Zoom IN/OUT.

### 2.[FOCUS]

- Use + / - to adjust PTZ Fous.

### 3.[PAN/TILT CONTROL]

- Click the direction buttons to control Pan and Tilt.

### 4.[PTZ ID]

- Show the PTZ ID that is under control.

### 5.[+/-]

- Click +/- to select a PTZ ID.

# JPEG2000 Stand alone DVR User Guide

## 7-4-6 Remote playback

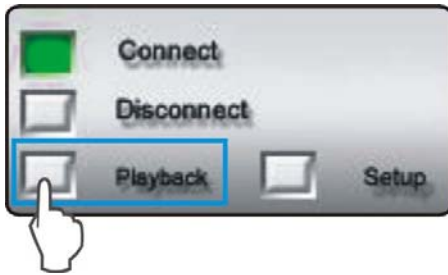

- When the DVR is connected, click [PLAYBACK] to enter Playback interface.

### [Remote Playback Interface]

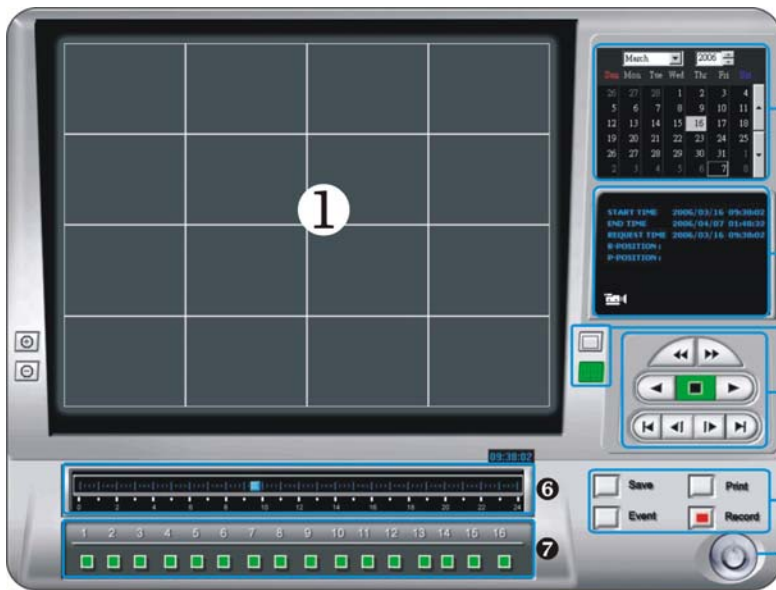

- 1.[Playback Picture]
  - To show the playback video
- 2.[Time/Date Selection]
  - To select time/date of playback
- 3.[Record and Playback Status]
  - START – To show the record START Time/Date
  - END – To show the record END Time/Date
  - REQUEST – To show the record DISPLAY Time/Date
- 4.[Screen Split]
  - To select Full/4/9/16 split screen display

### 5.[ Search Button ]

- To operate the search function

### 6.[Time Selection]

- To select the time of playback

### 7.[Channel Selection ]

- To select CAM1~16 when full screen display

### 8. [Auxiliary Function Button]

- SAVE : To save image as JPEG file to PC when the playback is paused.
- PRINT : To print out the picture when the playback is paused.
- EVENT : To show the DVR's event list.
- RECORD : To save the record image to the assigned path as AVI format.
- User can play AVI file by Windows Media Player.

### 9.[ Power]

- To close the playback program and return to Remote Viewer.

# JPEG2000 Stand alone DVR User Guide

## [Search button]

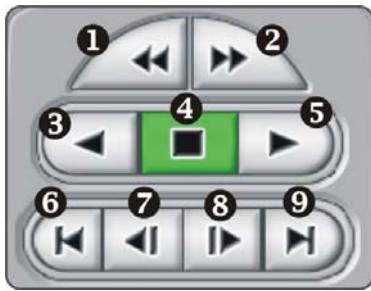

1. Fast Reward (RW)
2. Fast Forward (FF)
3. RW (Speed 1X)
4. Stop / Pause
5. Playback (Speed 1X)
6. Go to the beginning of recording
7. Jump to the previous hour
8. Jump to the next hour
9. Go to the end of recording

## [Remote Playback Operation]



- Drag the mouse over the time bar to select a playback time.

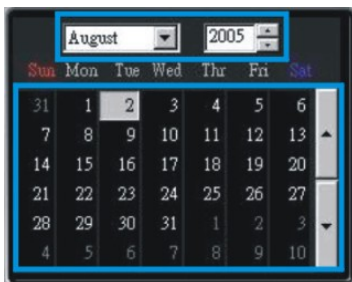

- Select a Year/Month/Day to playback.



- Click RW or PLAYBACK to start the playback
- If the DVR cannot find the selected playback date and time, the playback will start from the next video clip.

## [Playback by EVENT LIST]



- You can search a playback video clip by EVENT LIST. The events include Video Loss, Motion and Alarm.
- Press "EVENT"

Channel	Alarm Type	Date/Time
CH1	no loss -> loss	[2004/08/28] 11:01:51
CH2	no loss -> loss	[2004/08/28] 11:01:54

- Select an event from Event List and click twice to start playback

# JPEG2000 Stand alone DVR User Guide

---

## 7-4-7 Back up via Client software

- Save the recorded data as single JPEG picture or AVI format.

[Save the recorded data as single JPEG picture]



- Press "STOP" right before where you want to save and press "SAVE".
- The picture will be saved to the assigned path which you set up in **7-4-4 [Remote software setup] ▶ [PTZ/SAVE]**

[print the recorded data]



- Press "STOP" and "PRINT" to print out the picture.

[SAVE AS AVI]



- During playback, press "RECORD" to start saving to AVI and press "RECORD" again to stop.
- A message "Saving OK" pops up when you successfully save the video to AVI.

# JPEG2000 Stand alone DVR User Guide

## 7-5 DDNS setup and operation

### ➤ DDNS SERVER setup

The screenshot shows the top navigation bar with 'HOME', 'REGISTER', and 'F & Q' buttons. The 'REGISTER' button is highlighted with a red box. Below the navigation bar is the 'DDNS REGISTER' section with a form containing 'GROUP' and 'Password' input fields, a 'LOG IN' button, and a 'Forget password' link.

Copyright © 2005 JPEG2000

1. Connect to DDNS SERVER(<http://advr.com.tw> or <http://59.124.143.151>) by IE browser
  - Select [REGISTER] to register a new account

The screenshot shows the 'New User' registration form with fields for 'GROUP', 'User Password', 'Confirm Password', and 'E-mail'. There is an 'OK' button at the bottom of the form. The navigation bar on the left includes 'HOME', 'REGISTER', and 'F & Q' buttons.

Copyright © 2005 JPEG2000

2. Add a new account
  - Group: Add a new user name
  - User Password: Add user password
  - Confirm Password: Confirm the password
  - E-mail: Add an Email address for the password reminders

The screenshot shows the login form with 'GROUP' and 'Password' input fields, a 'LOG IN' button, and a 'Forget password' link.

3. Enter group name and password to LOGIN DDNS function.

# JPEG2000 Stand alone DVR User Guide

## DVR LIST

DVR Name   [Backup Player](#) [Add DVR](#) [User logout](#)

Number	DVR Name	MAC Address	IP	PORT	Last Modified Year/M / D H : M	Web/Backup/Edit/Delete
No DVR DATA						

4. Select "ADD DVR" to add DVR information

DVR Name	<input type="text"/>
MAC Address	<input type="text"/>
IP	<input type="text"/>
Port	<input type="text"/>
<input type="button" value="OK"/>	

5. Add DVR information:

- DVR NAME: Set a DVR name  
MAC ADDRESS: Enter the DVR's MAC address. DVR's MAC address can be found in DVR's [SYSTEM MENU] ► [EXTERNAL DEVICE] ► [TCP/IP SETUP] ► [IP CONFIG SETUP]  
IP: Enter the DVR's current IP address  
PORT: Enter the DVR's port number  
✂It is required to enter DVR NAME and MAC ADDRESS. DVR's IP and PORT number can be left blank..
- Press [OK] to save the settings

## DVR LIST

DVR Name   [Backup Player](#) [Add DVR](#) [User logout](#)

Number	DVR Name	MAC Address	IP	PORT	Last Modified Year/M / D H : M	Web/Backup/Edit/Delete
1	demo	000A01020304				Web/Backup/Edit/Delete

6. Edit and delete DVR information

- EDIT: To edit the DVR information  
DELETE: To delete the DVR information

# JPEG2000 Stand alone DVR User Guide

## ➤ DVR setup

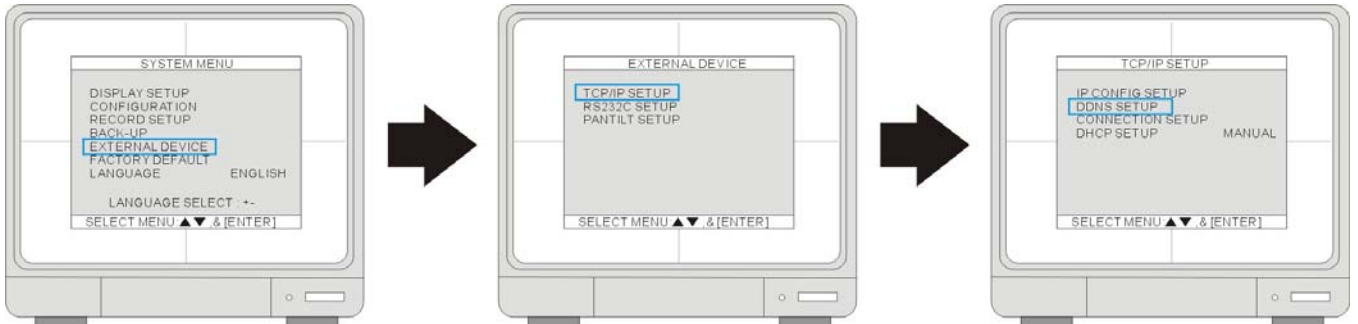

1. The DVR setup is a onetime effort. First, make sure your DVR can be accessed over the Internet. Please refer to **7-2 Network installation and setup** for details.

2. Go to **[SYSTEM MENU] ▶ [EXTERNAL DEVICE] ▶ [TCP/IP SETUP] ▶ [DDNS SETUP]**

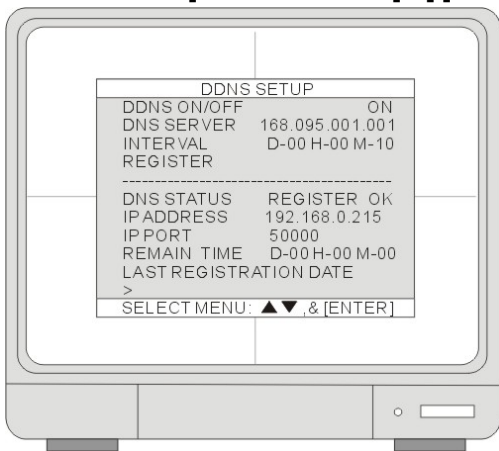

**DDNS IP: 59.124.143.151**

- **DDNS ON/OFF:** Press ENTER to turn ON the DDNS service.
- **DNS SERVER:** Enter the DDNS Server IP address.
- **INTERVAL:** Set an interval for the DVR to auto-update its IP address to DDNS server. (D- day / H- hour / M- minute)
- **REGISTER:** Connect to DDNS server and register the DVR information to DDNS database
- **DNS STATUS:** Indicate the current status of DDNS connection
- **IP ADDRESS:** Indicate the current IP address in DDNS server
- **IP PORT:** Indicate the current IP address in DDNS server
- **REMAIN TIME:** Indicate the remaining time to update the IP address
- **LAST REGISTRATION DATE:** Indicate the last date of registration

## ➤ Client software setup

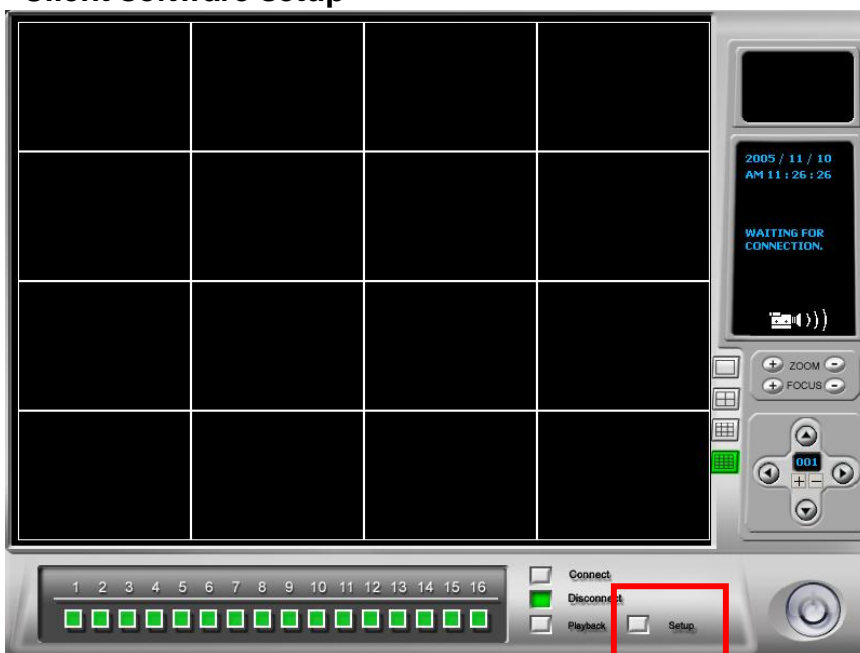

1. Run Client software and enter SETUP



# JPEG2000 Stand alone DVR User Guide

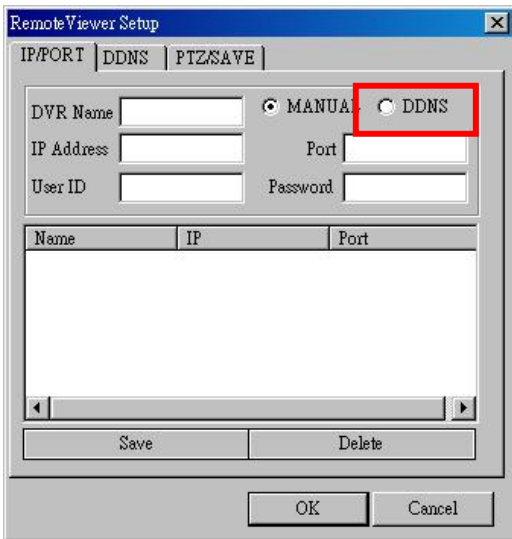

2. Select DDNS in [IP/PORT] setup

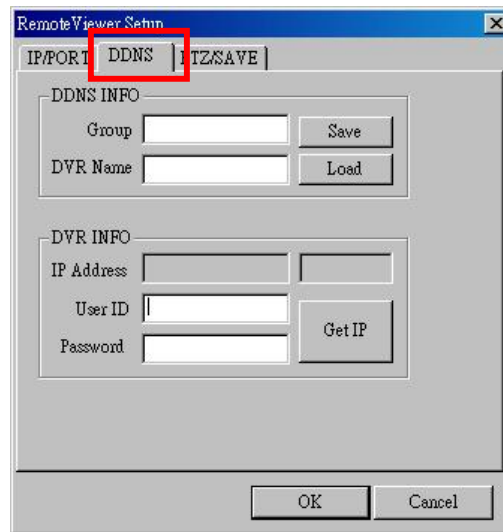

3. Go to DDNS setup

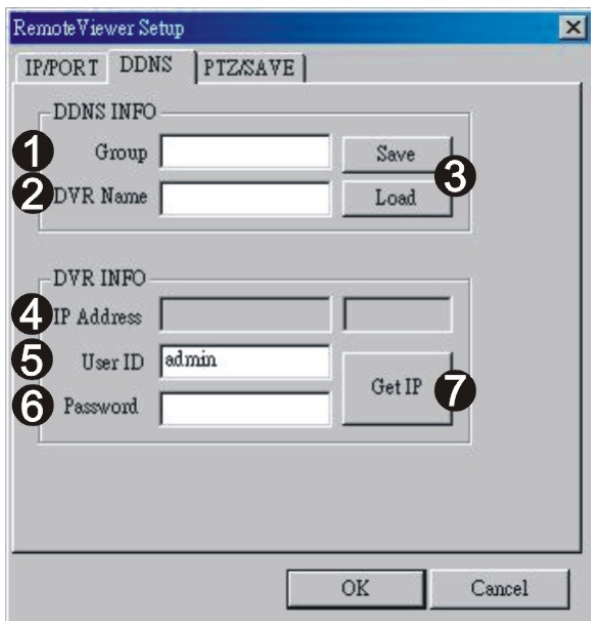

## [DDNS INFO]

- **GROUP:** Enter Group name registered on DDNS Server.
- **DVR NAME:** Enter DVR name registered on DDNS Server. If the DVR name is entered and saved before, click LOAD to browse the list.
- **Save/Load:**  
Save: Save the setup into the DDNS list.  
Load: Open the DDNS list.

## [DVR INFO]

- **Get IP:** Click "Get IP" to get the current DVR IP address and port number from DDNS server.
- **IP Address:** Show DVR's current IP address and Port number
- **User ID:** Enter ADMIN
- **Password:** Enter the DVR Admin's password and click OK to complete the DDNS setup.

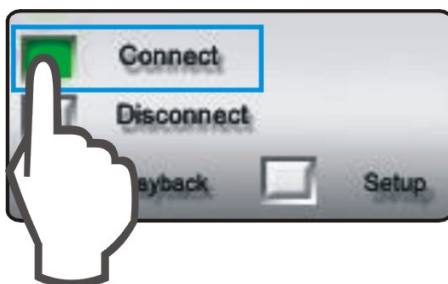

- Click "CONNECT" to get the connection with DVR

# JPEG2000 Stand alone DVR User Guide

## ➤ Configuration of DDNS connection

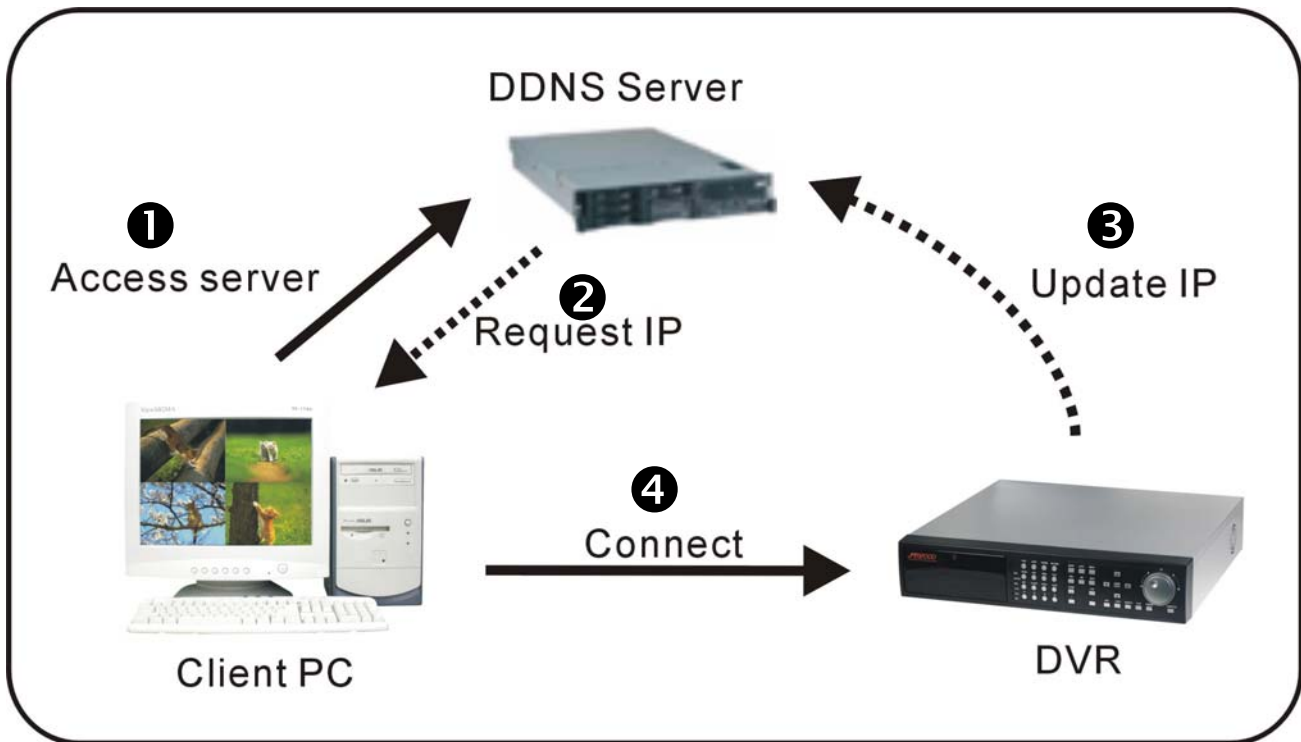

1. DVR connect to DDNS server automatically and update the IP address by itself.
2. The client accesses to DDNS server and requests IP address from DDNS server.
3. DDNS server replies the DVR's IP address and port number.
4. Client PC connects to DVR.

# JPEG2000 Stand alone DVR User Guide

Users can also access to the DVR from Internet Explore for remote viewing, remote backup, and playback the backup file. Log on to DDNS server and go to the DVR List

## ➤ Remote Live View via IE Browser

- Click WEB to link to your DVR

### DVR LIST

DVR Name	<input type="text"/>	OK	Backup Player	Add DVR	User logout	
Number	DVR Name	MAC Address	IP	PORT	Last Modified Year/M / D H : M	Web/Backup/Edit/Delete
1	demo	000A01020304				Web/Backup/Edit/Delete

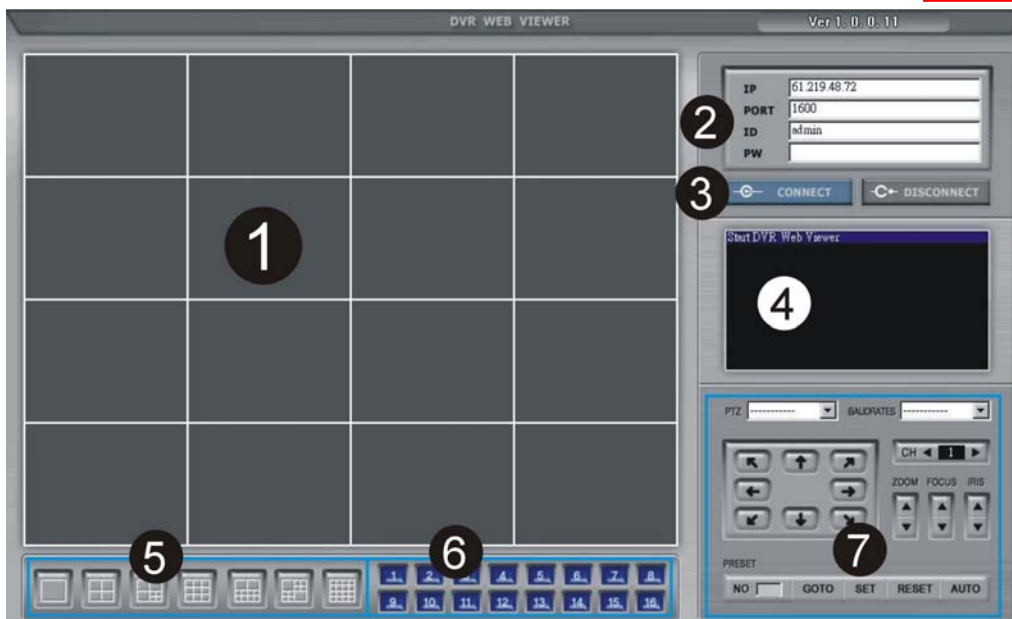

#### 1.[Live picture]

- Shows the live pictures of DVR

#### 2.[DVR info]

- IP: Indicate the IP address of DVR
- PORT: Indicate the PORT of DVR
- ID: Use ADMIN
- PW: Enter the ADMIN's password

#### 3.[CONNECT/DISCONNECT]

- CONNECT: Connect to DVR and get the live picture
- DISCONNECT: Interrupt the connection with DVR

#### 4.[Status Window]

- Shows the current status of connection

#### 5.[Selection of multi screen]

- Switch to the different modes of multi-screen displays

#### 6.[Channel selection]

- Select a single channel for full screen display

#### 7.[PTZ control]

- Control PTZ camera

# JPEG2000 Stand alone DVR User Guide



- PTZ: Select the protocol
- BAUDRATE: Select the baud rate
- CH: Select the ID of PEZ camera
- ZOOM: Zoom in/out
- FOCUS: Focus near/far
- IRIS: IRIS open/close
- [PRESET]
- GOTO: Active the preset function
- SET: Set the preset location
- RESET: Reset the preset location
- AUTO: Auto Scan the PTZ camera

## ➤ Web Network Backup

### DVR LIST

DVR Name   [Backup Player](#) [Add DVR](#) [User logout](#)

Number	DVR Name	MAC Address	IP	PORT	Last Modified Year/M / D H : M	Web/Backup/Edit/Delete
1	demo	000A01020304				Web/Backup/Edit/Delete

- Click "Backup" to open the web page "Web Network Backup"

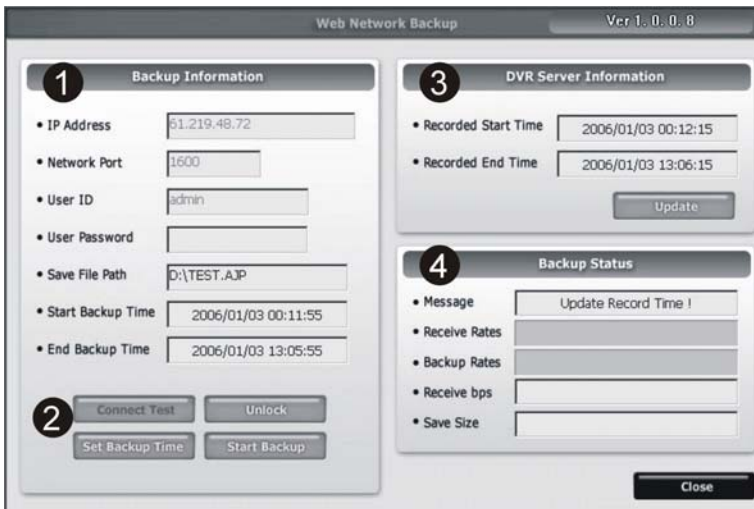

#### 1.Backup Information:

- IP Address: Enter the IP address of DVR
- Network Port: Enter the port of DVR
- User ID: Enter "Admin"
- User Password: Enter Admin's password
- Save File Path: Set a path to save the backup file (This function is active only when the connection is established)
- Start Backup Time: The start time of file backup (This function is only active under the connection is established")
- End Backup Time: The end time of file backup (This function is only active under the connection is established")

# JPEG2000 Stand alone DVR User Guide

## 2. Function setup:

- Connect Test: To test the connection status  
Unlock: To get the record start/End time of DVR  
Set Backup Time: Set the start/end time, size and path of file backup  
Start Backup: Active the backup function

## 3. The information of DVR Server:

- Recorded Start Time: Indicate the recorded start time  
Recorded End Time: Indicate the recorded end time
- Update: Update the recorded time

## 4. Backup Status

- Message: Indicate the backup status  
Receive Rate: Indicate the percentage of backup image received  
Backup Rate: Indicate the completed percentage of backup image received  
Receive bps: Indicate the bps of backup image received  
Save Size: Indicate the size of backup image saved

## ➤ Backup Procedure

1. Select [Connect Test] to test the status to DVR connection
2. Select [Unlock] to get the record start/End time of DVR
3. Select [Set Backup Time] to setup the backup function

The screenshot shows a 'Backup Information' dialog box with the following fields and annotations:

- Recorded Start Time:** 2006/01/03 04:51:32 (Annotation 1)
- Recorded End Time:** 2006/01/03 17:46:36
- Save File Path:** D:\TEST.AJP (Annotation 2 points to the Find button)
- Maximum Save File Size:** 30 MB (Annotation 3)
- Start Backup Time:** Year: 2006, Month: 1, Day: 3, Hour: 4, Minute: 51 (Annotation 4)
- End Backup Time:** Year: 2006, Month: 1, Day: 3, Hour: 17, Minute: 46

Buttons: Apply, Close

- 1 Indicate the recorded start/end time
- 2 Click [Find] to set the path for saving the backup file
- 3 Set the file size of backup file (30~700MB)
- 4 Set the start/end time of file backup

4. Click [Apply] to apply all setup
5. Select [Start Backup] to active the backup function (User can stop anytime during backup)

# JPEG2000 Stand alone DVR User Guide

## ➤ Play backup file





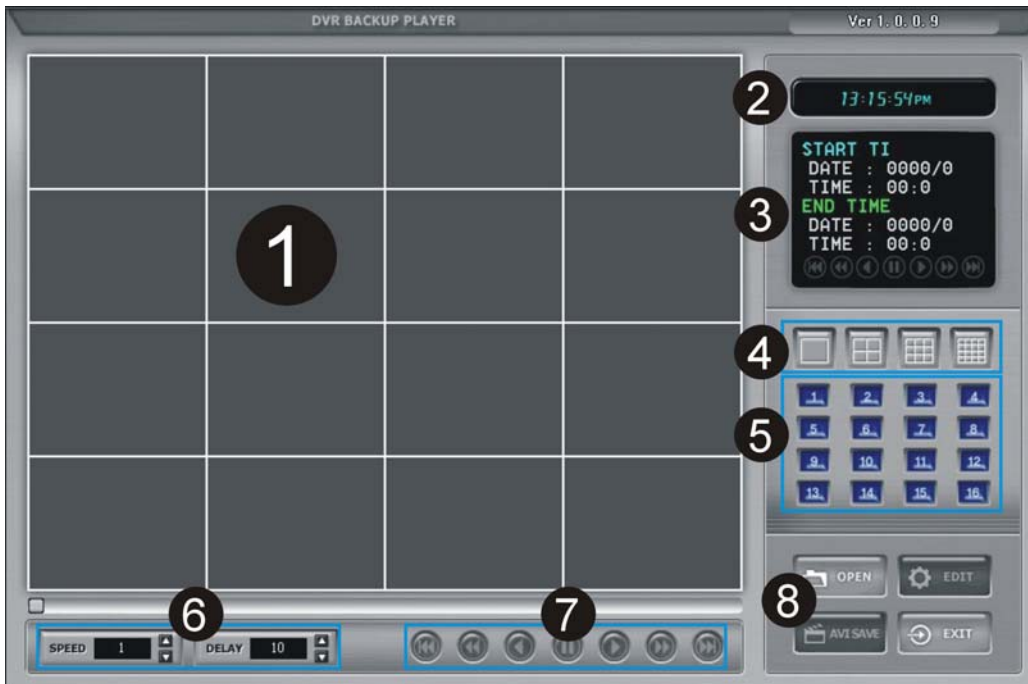

### DVR LIST

DVR Name	<input type="text"/>	OK	<b>Backup Player</b>	Add DVR	User logout	
Number	DVR Name	MAC Address	IP	PORT	Last Modified Year/M/ D H : M	Web/Backup/Edit/Delete
1	demo	000A01020304				Web/Backup/ Edit / Delete

- Click [Backup Player] to open the web page of “Backup Player”



1. Display the backup image
2. Indicate the present time of monitoring
3. Indicate the start/end time of backup file
4. Switch to the different modes of multi-screen
5. Channel selection: Ch1~Ch16
6. SPEED: Adjust the speed of fast forward    DELAY: Adjust the speed of reward
7. Function bar on playback:



-  To the beginning
-  Fast Rewind ◦
-  Rewind
-  Pause
-  Forward
-  Fast Forward
-  To the end

# JPEG2000 Stand alone DVR User Guide

## 8. Function keys:

- OPEN: Open the backup file  
EDIT: Edit the backup image  
AVI SAVE: To save the AVI file  
EXIT: Log out the program

### ➤ Save AVI file:

1. Click  to open the backup file and select  single channel

2. Click  to open the AVI SAVE function

3.  CHANNEL: Select a single channel  
FRAMERATE : Set the frame rate  
SIZE: Set the file size of AVI SAVE  
START: Start AVI SAVE  
STOP: Stop AVI SAVE

※ The AVI file path will be saved under C:\WEB\_BACKUP

# JPEG2000 Stand alone DVR User Guide

## Appendix.1 Record time table

[4ch DVR]

HDD Capacity (GB)	NTSC				
	Low	Mid	High	Super	Hyper
	12K	18K	24K	32K	40K
20	8.1Hr	5.3Hr	4.0Hr	3.0Hr	1.9Hr
40	16.2Hr	10.6Hr	8.0Hr	6.0Hr	3.9Hr
60	24.3Hr	15.9Hr	12.0Hr	9.0Hr	5.9Hr
80	32.3Hr	21.5Hr	16.1Hr	12.1Hr	7.9Hr
120	48.5Hr	32.3Hr	24.2Hr	18.2Hr	14.5Hr
160	64.7Hr	43.1Hr	32.3Hr	24.2Hr	19.4Hr
200	80.9Hr	53.9Hr	40.4Hr	30.3Hr	24.2Hr
250	101.1Hr	67.4Hr	50.5Hr	37.9Hr	30.3Hr
300	121.3Hr	80.9Hr	60.6Hr	45.5Hr	36.4Hr
400	161.8Hr	107.8Hr	80.9Hr	60.6Hr	48.5Hr

HDD Capacity (GB)	PAL				
	Low	Mid	High	Super	Hyper
	14K	20K	24K	32K	40K
20	8.3Hr	5.8Hr	4.9Hr	3.6Hr	2.9Hr
40	16.6Hr	11.6Hr	9.7Hr	7.2Hr	5.8Hr
60	25.0Hr	17.4Hr	14.6Hr	10.8Hr	8.7Hr
80	33.3Hr	23.3Hr	19.4Hr	14.5Hr	11.6Hr
120	49.9Hr	34.9Hr	29.1Hr	21.8Hr	17.4Hr
160	66.6Hr	46.6Hr	38.8Hr	29.1Hr	23.3Hr
200	83.2Hr	58.2Hr	48.5Hr	36.4Hr	29.1Hr
250	104.0Hr	72.8Hr	60.7Hr	45.5Hr	36.4Hr
300	124.8Hr	87.3Hr	72.8Hr	54.6Hr	43.6Hr
400	166.4Hr	116.5Hr	97.1Hr	72.8Hr	58.2Hr

※The numbers are for reference only.

※The recording duration is calculated under the continuous recording mode (Record speed :1/1X)



# JPEG2000 Stand alone DVR User Guide

[8/16ch DVR]

HDD Capacity(GB)	NTSC				
	Basic	Normal	Enhanced	Fine	Super Fine
	12K	16K	20K	24K	28K
20	4.0Hr	3.0Hr	2.4Hr	2.0Hr	1.7Hr
40	8.1Hr	6.1Hr	4.9Hr	4.0Hr	3.5Hr
60	12.1Hr	9.1Hr	7.3Hr	6.1Hr	5.2Hr
80	16.2Hr	12.1Hr	9.7Hr	8.1Hr	6.9Hr
120	24.3Hr	18.2Hr	14.6Hr	12.1Hr	10.4Hr
160	32.4Hr	24.3Hr	19.4Hr	16.2Hr	13.9Hr
200	40.5Hr	30.3Hr	24.3Hr	20.2Hr	17.3Hr
250	50.6Hr	37.9Hr	30.3Hr	25.3Hr	21.7Hr
300	60.7Hr	45.5Hr	36.4Hr	30.3Hr	26.0Hr
400	80.9Hr	60.7Hr	48.5Hr	40.5Hr	34.7Hr

HDD Capacity(GB)	PAL				
	Basic	Normal	Enhanced	Fine	Super Fine
	14K	19K	24K	29K	32K
20	4.2Hr	3.1Hr	2.4Hr	2.0Hr	1.8Hr
40	8.3Hr	6.1Hr	4.9Hr	4.0Hr	3.6Hr
60	12.5Hr	9.2Hr	7.3Hr	6.0Hr	5.5Hr
80	16.6Hr	12.6Hr	9.7Hr	8.0Hr	7.3Hr
120	25.0Hr	18.4Hr	14.6Hr	12.1Hr	10.9Hr
160	33.3Hr	24.5Hr	19.4Hr	16.1Hr	14.6Hr
200	41.6Hr	30.7Hr	24.3Hr	20.1Hr	18.2Hr
250	52.0Hr	38.3Hr	30.3Hr	25.1Hr	22.8Hr
300	62.4Hr	46.0Hr	36.4Hr	30.1Hr	27.3Hr
400	83.2Hr	61.3Hr	48.5Hr	40.2Hr	36.4Hr

※The numbers are for reference only.

※The recording duration is calculated under the continuous recording mode (Record speed :1/1X)

# JPEG2000 Stand alone DVR User Guide

## Appendix.2 System configuration

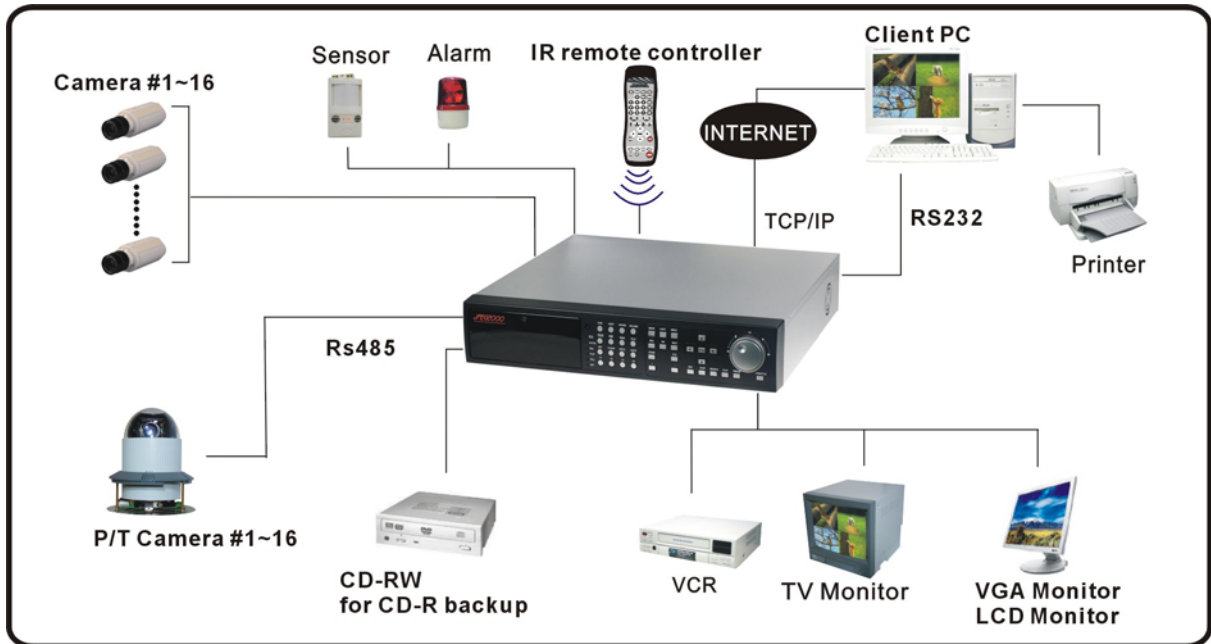

## Appendix.3 Firmware upgrade

### ➤ Install USB driver

1. Connect USB port between PC and DVR
2. Press and hold Search and Play keys on front panel and power on DVR
3. The DVR beeps for a moment.

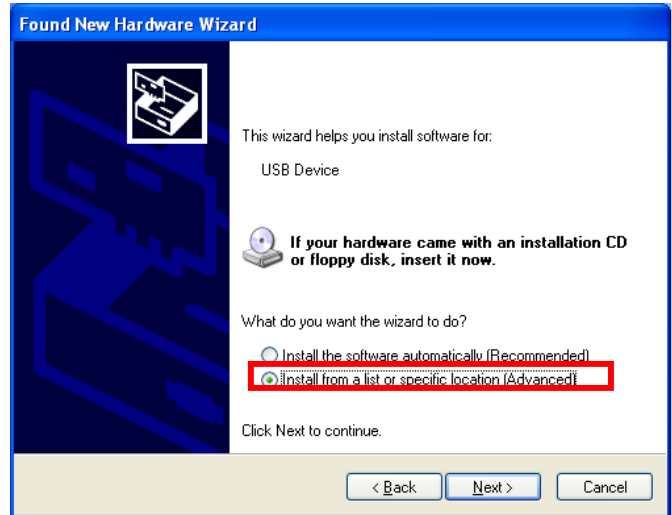
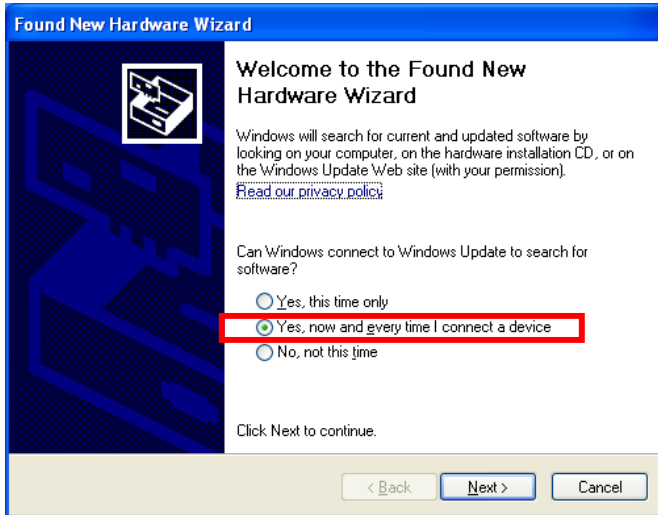

4. When the Windows system detect new device, please select [Install from a list or specific location]

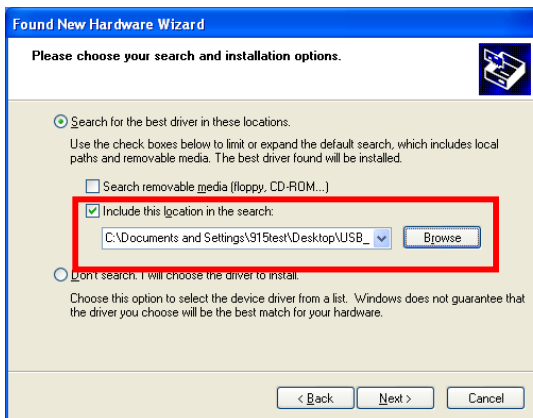

5. Select the location of USB driver

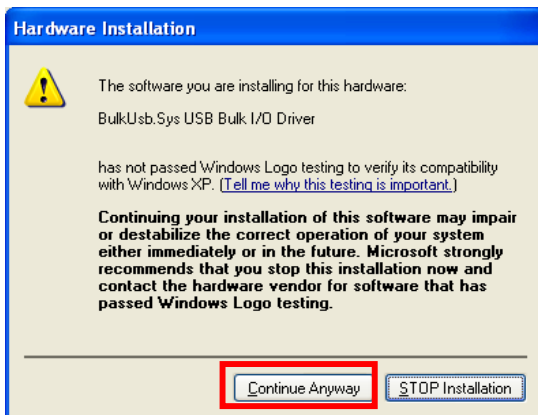

6. A warning message pop up while the driver is installing. Please select "Continue Anyway".

# JPEG2000 Stand alone DVR User Guide

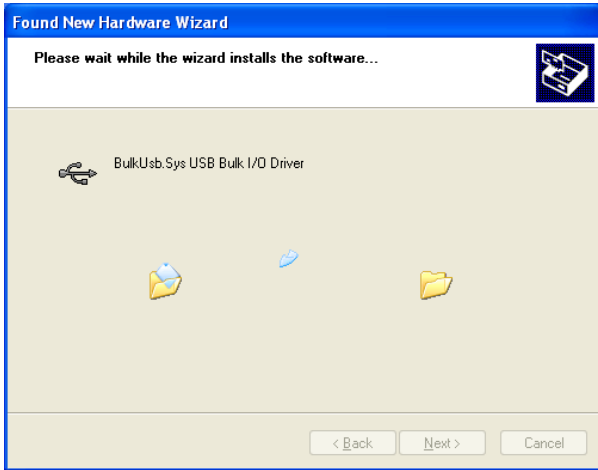

7. Start to copy the driver to Windows system.

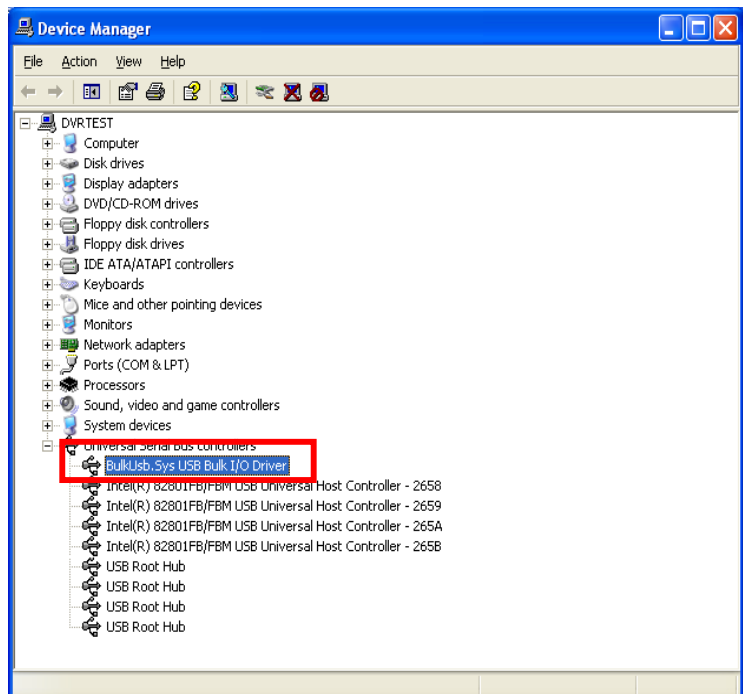
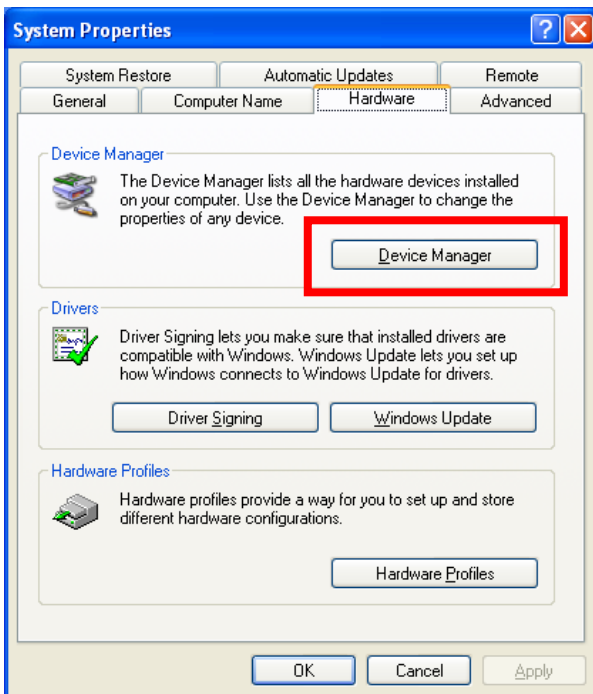

8. After installation, the USB device [BulkUsb.Sys Usb Bulk I/O Driver] can be found from [Device Manager].

# JPEG2000 Stand alone DVR User Guide

## ➤ Install USB upgrade program

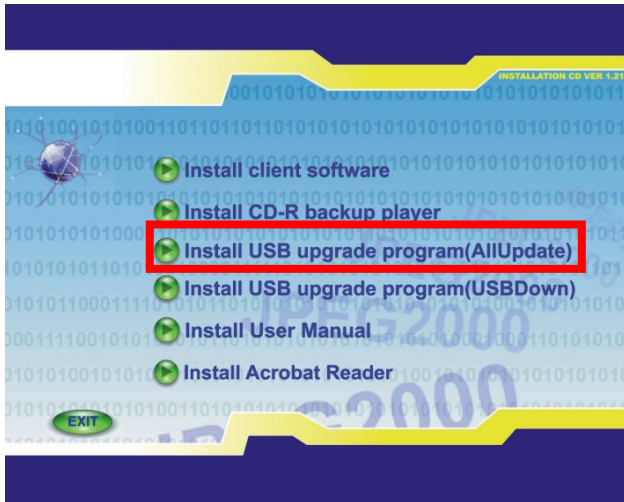

- Insert the Install CD

1. Please select : [Install USB upgrade program(Allupdate)]

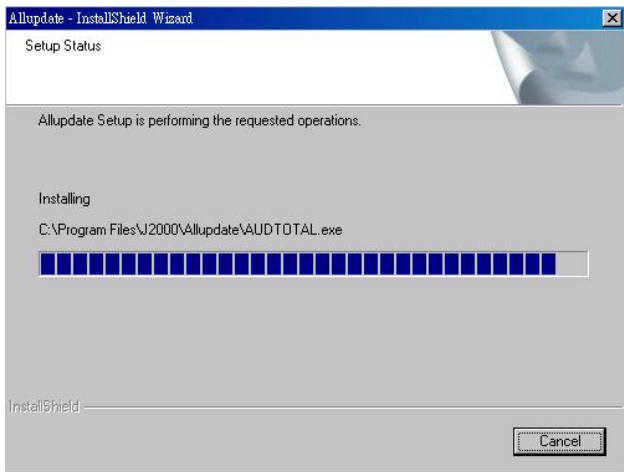

2. Set up Directory

※ (default Directory :

"C:\Program Files\J2000\Allupdate\"")

After installation, there'll be a shortcut on desktop.

Click on it for remote viewing.



# JPEG2000 Stand alone DVR User Guide

## ➤ Upgrade firmware

### ● Update procedures

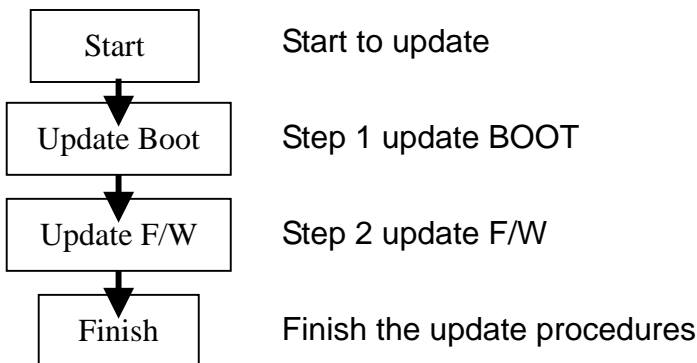

### ● Step 1 、 Update BOOT

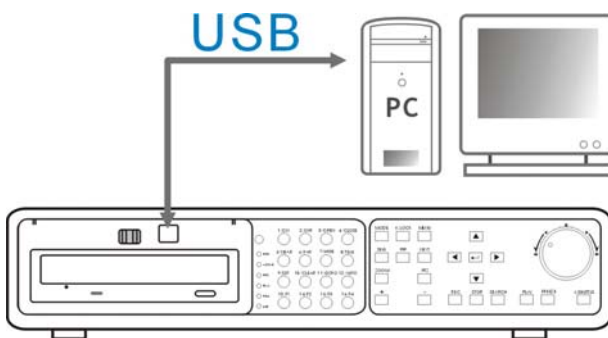

1. Connect the USB port between DVR and PC.  
(Do not power on DVR in advance)

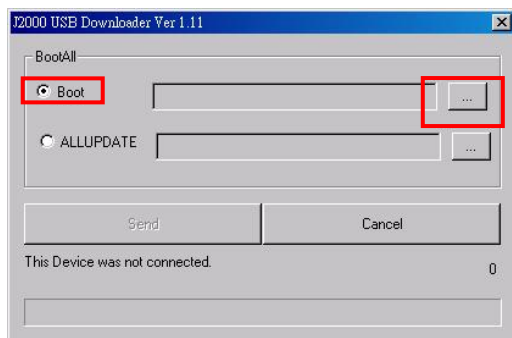

2. Execute USB update program AUDTOTAL · select “Boot” then choose the file: \_FBoot\_0000\_16M\_V2.04.bin
3. Press and hold SEARCH and PLAY key and power on the DVR.
4. When the DVR is powered on, you will hear very short beeps. Keep holding the “SEARCH” and “PLAY” buttons. When the beeps turn slow and the “Send” icon of the program, J2000 USB Downloader, becomes active, release the buttons

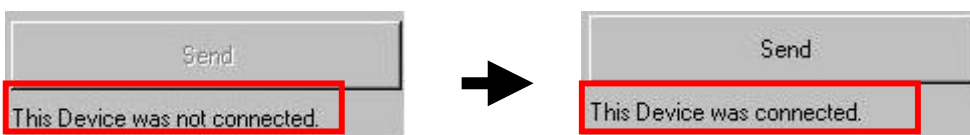

5. Click SEND for transmission. After transmission, the DVR will reboot automatically. When DVR shows HDD detection message, power off DVR.

# JPEG2000 Stand alone DVR User Guide

## ● Step 2 、 Update F/W

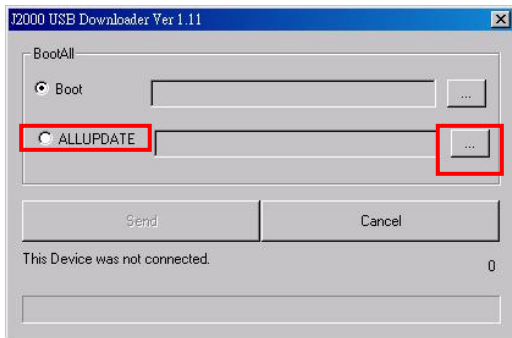

1. Select ALLUPDATE then choose the file: \_ALLUPDATE\_4J\_NTIC\_noboot\_V1.3.bin
2. Press and hold SEARCH and PLAY and power on the DVR
3. When the DVR is turned on, you will hear very short beeps. Keep holding the “SEARCH” and “PLAY” buttons. When the beeps turn slow and the “Send” icon of the program, J2000 USB Downloader, becomes active, release the buttons.

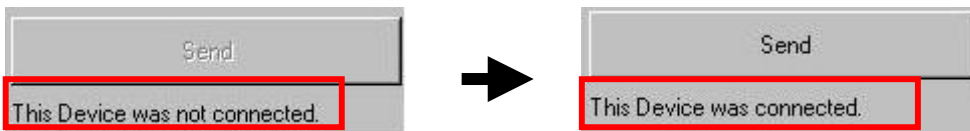

4. Click “SEND” to transmit the files. The DVR automatically reboots after the file transmission is completed. Congratulations, you have finished the update.

## Appendix.4 Play only mode

### ➤ Introduction

PLAY ONLY MODE can be used in the following situations:

- When you need to playback a hard drive from another DVR
- When you need to playback the video which you deleted by running HDD CLEAR

### ➤ Enter “PLAY ONLY MODE”

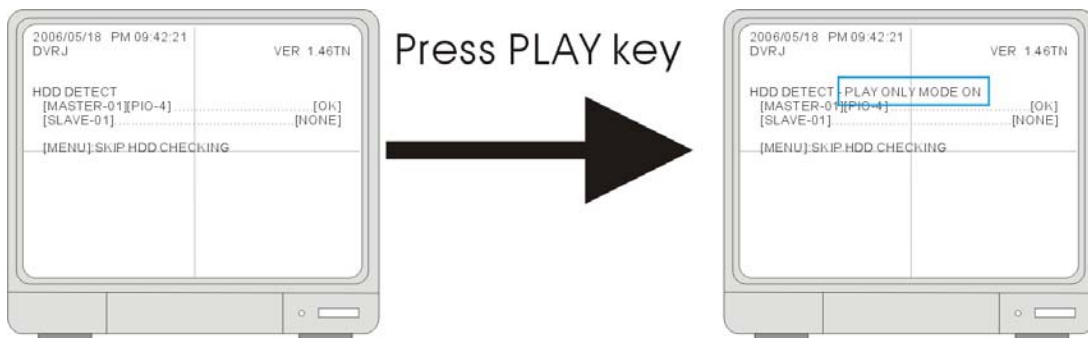

- Turn on the DVR. At the initial screen that says HDD DETECT, press [PLAY] and System enters “PLAY ONLY MODE”.
- To exit PLAY ONLY MODE, reboot the DVR and DO NOT press PLAY at the initial screen.

Under PLAY ONLY MODE:

1. DVR cannot record.
2. DVR cannot backup video to CD-R.
3. You still can connect to the DVR remotely. You can enter Playback remotely to search the data, but there is no remote LIVE display.

### ➤ Search

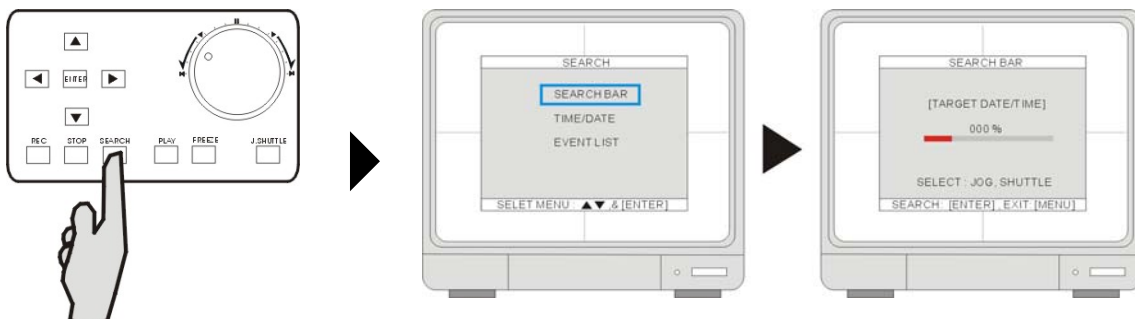

- Use Search Bar to search the data by percentage.
- You cannot use Time/Date and EVENT LIST to search the data.